

Thank you for selecting the *ZOOM STUDIO 1202* (hereafter called “The 1202”). The 1202 is a sophisticated effect processor with the following features:

- **A total of 512 preset effect programs (32 effects x 16 patterns) makes the unit immediately usable for a wide variety of creative applications.**
- **44.1 kHz sampling frequency assures high performance, ideal for processing sound sources such as guitar, bass, synthesizer, etc.**
- **Full stereo configuration—a first in this class— creates rich, natural reverb sounds. Using the two channels individually is also possible.**

Please take the time to read this manual carefully, in order to get the most out of your 1202 and to ensure optimum performance and reliability.

Safety Precautions

Please observe the following safety tips and precautions to ensure hazard-free use of the 1202.

• Power requirements

The 1202 is powered by the supplied AC adapter. Do not use any other kind of AC adapter to prevent malfunction and safety hazards.

When using the 1202 in an area with a different line voltage, please consult your local ZOOM distributor about acquiring a proper AC adapter.

• Environment

Avoid using your 1202 in environments where it will be exposed to:

- **Temperature extremes**
- **High humidity or moisture**
- **Excessive dust or sand**
- **Excessive vibration or shock**

• Handling

Since the 1202 is a precision electronic device, avoid applying excessive force to the switches and buttons. Also take care not to drop the unit, and do not subject it to shock or excessive pressure.

• Alterations

Never open the case of the 1202 or attempt to modify the product in any way since this can result in damage to the unit.

• Connecting cables and input and output jacks

You should always turn off the power to the 1202 and all other equipment before connecting or disconnecting any cables. Also make sure to disconnect all cables and the AC adapter before moving the 1202.

Usage Precautions

• Electrical interference

The 1202 uses digital circuitry that may cause interference and noise if placed too close to other electrical equipment, such as TV sets and radio receivers. If such problems occur, move the 1202 further away from the affected equipment. Also, when fluorescent lights or devices with built-in motors are close to the 1202, the unit may not function properly.

• Cleaning

Use a soft, dry cloth to clean the 1202. If necessary, slightly moisten the cloth. Do not use abrasive cleanser, wax, or solvents (such as paint thinner or cleaning alcohol), since these may dull the finish or damage the surface.

Please keep this manual in a convenient place for future reference.

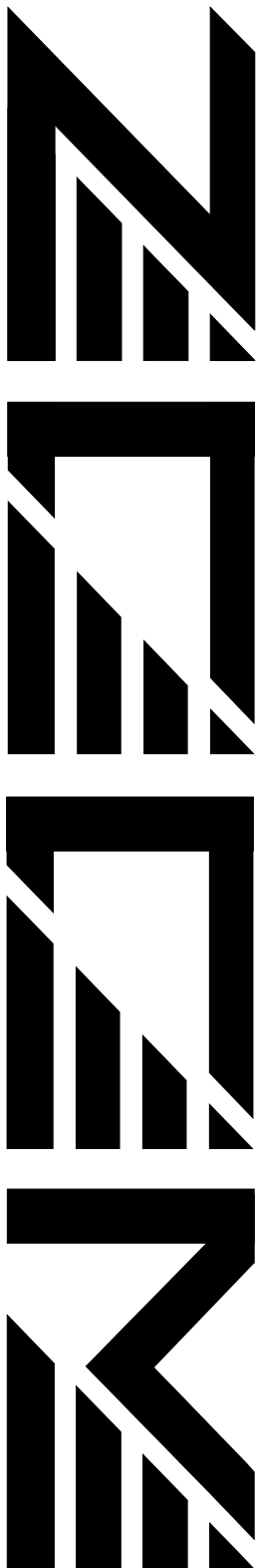

Names and Functions of Controls and Connectors

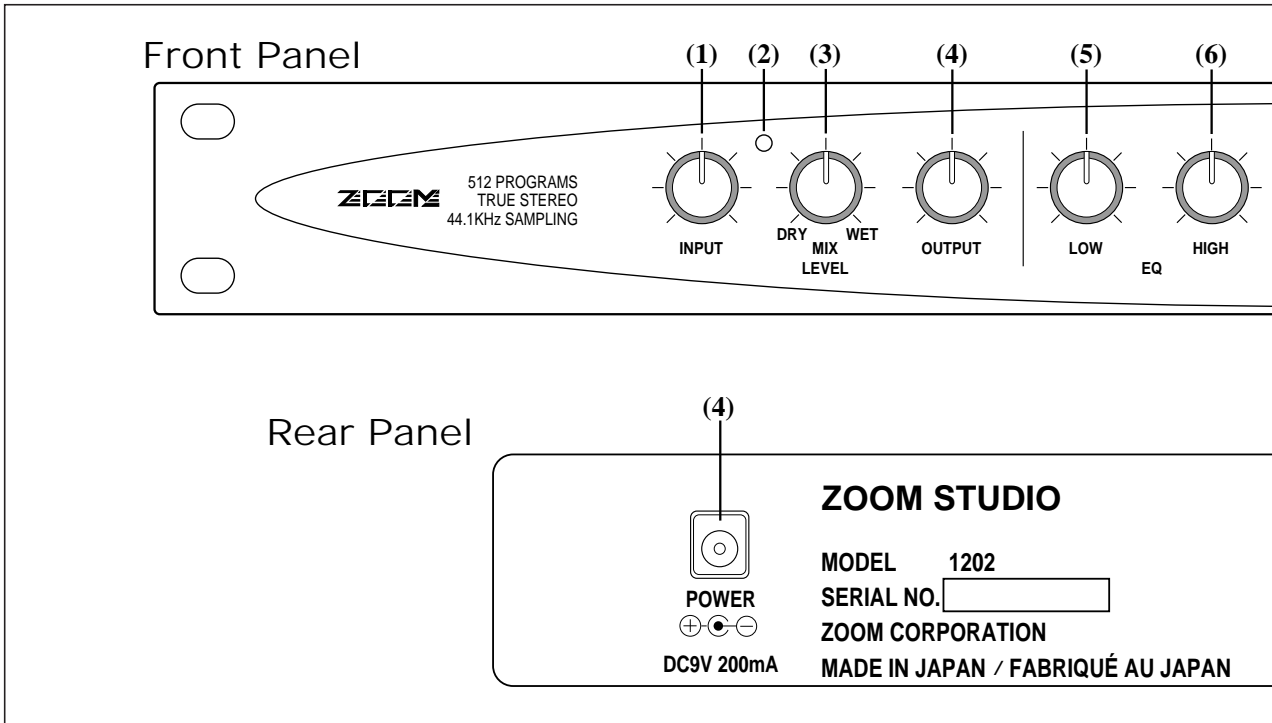

Front Panel

(1) INPUT control

Serves to adjust the volume of the sound source connected to the input.

(2) LED indicator

When the 1202 is turned on, this indicator lights up in green. If the level of the input signal is too high, the indicator turns red to show that the sound will be distorted. Adjust the INPUT control so that the indicator flashes briefly red on the highest signal peaks.

(3) MIX control

Serves to adjust the level balance between the original sound and the effect sound. When the control is turned fully counterclockwise, only the original sound is heard. When the control is turned fully clockwise, only the effect sound is heard.

(4) OUTPUT control

Serves to adjust the output signal level.

(5) EQ LOW control

(6) EQ HIGH control

These controls serve to adjust the low and high frequency range of the effect signal.

 **NOTE** When a compound effect (indicated by a / in the effect name) is selected for bank B, the EQ LOW and EQ HIGH controls affect only the reverb or the echo effect sound.

(7) EFFECT selector

Serves to select the effect type to be used. There are 16 different effect types for bank A and bank B.

(8) BANK switch

Serves to select the effect bank A or B.

(9) PATTERN selector

Determines the application pattern of the selected effect. For each effect, 16 different patterns are available.

(10) EDIT1 control

(11) EDIT2 control

These controls serve to adjust the parameters of the currently selected effect. Which parameters can be controlled depends on the selected effect and the selected pattern. (Refer to the supplied preset program list.)

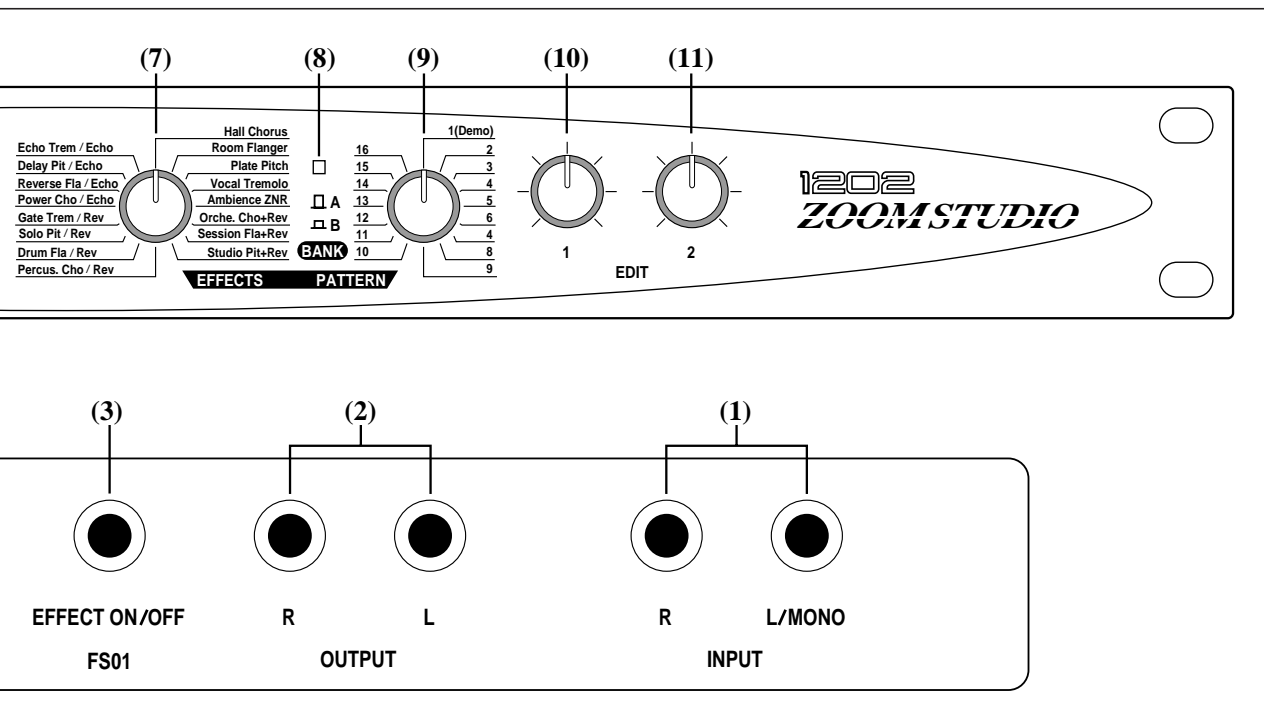

Rear Panel

(1) INPUT connector

Serves for connection of the sound source signal from an instrument, mixer send, etc.



NOTE When wishing to use equipment with low output, such as a guitar, electric bass or microphone, a preamplifier or a mixer with an integrated preamplifier must be connected between the equipment and the 1202.

(2) OUTPUT connector

Serves for connection to the return input of the instrument or mixer, or to the playback system.

(3) EFFECT OFF connector

By connecting the optional foot switch FS01 to this jack, effects can be switched on and off externally. When OFF is selected, only the original signal is output, and the power LED on the front panel flashes in orange.

(4) POWER (AC adapter) connector

Serves for connection of the supplied AC adapter. Be sure to use only the supplied adapter. When the AC adapter is plugged into an AC outlet, the 1202 will be automatically switched on.

Specification

Preset Programs:	512 (16 Effects × 2 Banks; A/B × 16 Patterns)
Program Controls:	2 (EDIT 1, EDIT 2)
Effect EQ:	HIGH, LOW
Level & Mix Controls:	INPUT, MIX (100% DRY — 100% EFFECT), OUTPUT
Rear I/O:	INPUTS (L/MONO, R) ; -10dBm — +4dBm / 7kΩ (MONO), 14kΩ (STEREO) OUTPUTS (L, R) ; -10dBm — +4dBm / 330Ω or more EFFECT OFF (with optional foot switch FS01)
A/D Conversions:	2 channels, 16 bit Linear, 44.1kHz, 64 times over sampling
D/A Conversions:	2 channels, 16 bit , 44.1kHz
Dimensions:	W 482 × H 44 × D 115 mm
Weight:	1.4 kg

Setup Examples

1. Connection between instrument and playback system

This example demonstrates the use of the 1202 as an instrument effector. For a monaural setup, use only the left (L) connector. The MIX control should normally be set to the center position.

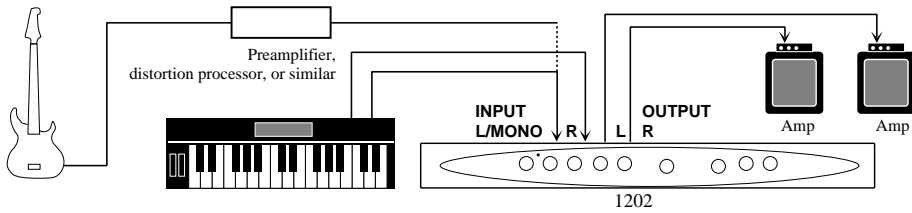

2. Connection in send/return loop of a mixer

This type of connection allows use of the 1202 for any instrument or sound source connected to the mixer. The MIX control should normally be turned fully clockwise.

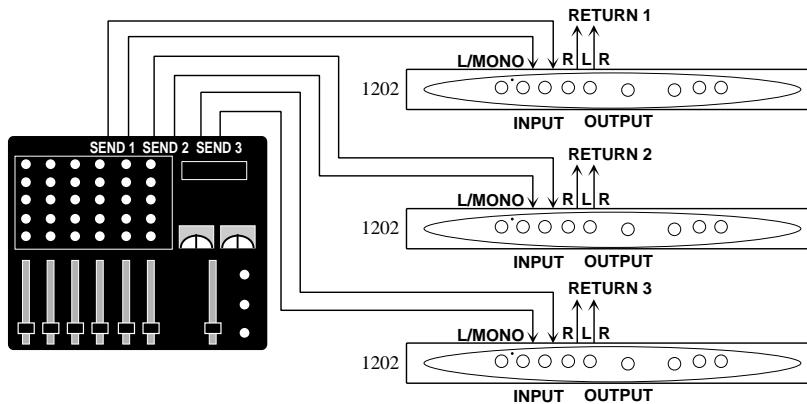

3. Successive use of two effect types

When a compound effect (indicated by a / in the effect name) is selected, two types of effects can be used in series, as shown in this example. It is also possible to insert an external effector between the first and second effect.

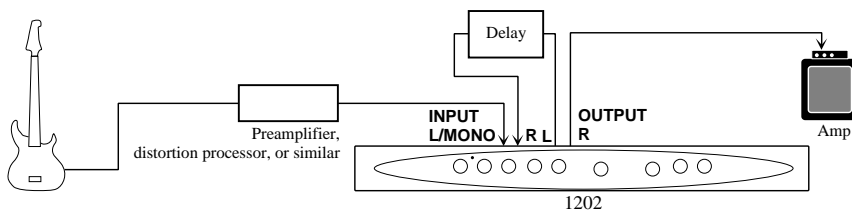

4. Parallel use of two effect types

When a compound effect (indicated by a / in the effect name) is selected, two types of effects can be used separately, as shown in this example.

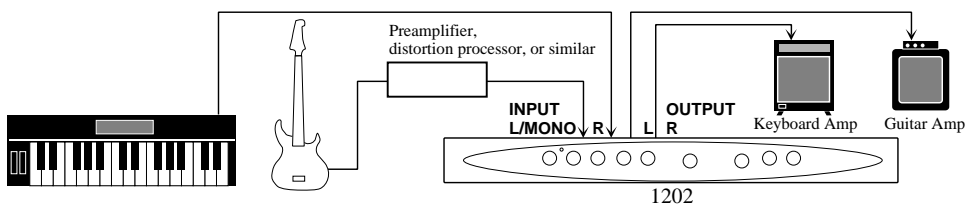

ZOOMSTUDIO 1202 EFFECT PROGRAM LIST

BANK A

Effects	Description	Patterns	EDIT 1	EDIT 2
1. Hall	Simulates a medium-sized concert hall	Pattern 2–16: Variations with different reverb time 1: 2.2Sec/2–16: 1.0–3.8Sec	Diffusion	Attack
2. Room	Simulates an acoustically dead space such as a rehearsal studio	Pattern 2–16: Variations with different reverb time 1: 0.7Sec/2–16: 0.5–3.3Sec	Diffusion	High Cut
3. Plate	Reverb with rich bass	Pattern 2–16: Variations with different reverb time 1: 4.2Sec/2–16: 3.0–9.0Sec	Pre Delay 0–100mS	High Mpy
4. Vocal	Reverb for adding depth and suppleness, to vocals	Pattern 2–16: Variations with different reverb time 1: 4.5Sec/2–16: 1.7–4.5Sec	Pre Delay 0–100mS	Attack
5. Ambience	Reverb for brightening up the sound and adding depth	Pattern 2–16: Variations with different reverb time 1: 1.2Sec/2–16: 0.6–3.4Sec	High Damp	Density
6. Orche.	Reverb with very wide sound stage and distinct body	Pattern 2–16: Variations with different reverb time 1: 1.5Sec/2–16: 0.5–3.3Sec	Pre Delay 0–100mS	Density
7. Session	Simulates a small, acoustically live room	Pattern 2–16: Variations with different reverb time 1: 1.0Sec/2–16: 0.6–3.4Sec	Diffusion	High Cut
8. Studio	Simulates a large studio with high ceiling	Pattern 2–16: Variations with different reverb time 1: 0.9Sec/2–16: 0.5–3.3Sec	Pre Delay 0–100mS	High Cut

* For each effect, pattern 1 is called DEMO (standard setting).

[EDIT 1/2 Parameters]

Diffusion: Adjusts the reverb spread.

Attack: Stresses the reverb attack.

High Cut: Attenuates the high frequency components in the reverb.

Pre Delay: Adjusts the interval between the original sound and the reverb.

High Mpy: Adjusts the duration of high-frequency reverb components.

High Damp: Adjusts the speed with which the high-frequency reverb components are attenuated.

Density: Adjusts the reverb density.

ZOOMSTUDIO 1202 EFFECT PROGRAM LIST

BANK A

Effects	Description	Patterns	EDIT 1	EDIT 2
9. Percus.	Conventional type reverb suitable for all kinds of percussion	Pattern 2–16: Variations with different reverb time 1: 1.8Sec/2–16: 0.6–3.4Sec	Diffusion	High Damp
10. Drums	Reverb suitable for adding body to snare drums	Pattern 2–16: Variations with different reverb time 1: 1.7Sec/2–16: 0.5–3.3Sec	High Damp	Density
11. Solo	Reverb with pronounced predelay, ideal for reed solos	Pattern 2–16: Variations with different gate time 1: 3.5Sec/2–16: 2.3–55Sec	Pre Delay 0–100mS	High Cut
12. Gate	Intense gate type reverb	Pattern 2–16: Variations with different gate time 1: 448mS/2–16: 88–1,152mS	Density	Gate Threshold
13. Power	Gate type reverb for creating a heavy sound	Pattern 2–16: Variations with different gate time 1: 312mS/2–16: 88–1,152mS	High Damp	Gate Threshold
14. Reverse	Effect similar to a tape recorder running backwards	Pattern 2–16: Variations with different gate time 1: 858mS/2–16: 88–1,152mS	Diffusion	Gate Threshold
15. Delay	Long delay up to 740 ms, with cross-feedback between L and R. Use EDIT 1/2 to adjust L/R delay time.	Pattern 2–8: Variations with different feedback time. The delay time variation range is 0.4 to 180 mS. Pattern 9–16: Variations with different feedback time. The delay time variation range is 11 to 370 mS. 1: L: 185mS R: 173mS	Delay Time 1 0.4–180mS OR 11–370mS	Delay Time 2 0.4–180mS OR 11–370mS
16. Echo	Fully discrete two-channel echo. Use EDIT 1/2 to adjust L/R delay time.	Pattern 2–8: Variations with different feedback time. The delay time variation range is 0.4 to 180 mS. Pattern 9–16: Variations with different feedback time. The delay time variation range is 11 to 370 mS. 1: L: 173mS R: 185mS	Delay Time 1 0.4–180mS OR 11–370mS	Delay Time 2 0.4–180mS OR 11–370mS

* For each effect, pattern 1 is called DEMO (standard setting).

[EDIT 1/2 Parameters]

Gate Threshold: Adjusts the gate threshold.

Delay Time 1/2: Adjusts the interval between the original sound and delay sound, and between delay components.

ZOOMSTUDIO 1202 EFFECT PROGRAM LIST

BANK B

Effects	Description	Patterns	EDIT 1	EDIT 2
17. Chorus	Chorus with a total of six voices for L and R	Pattern 2–16: Variations with different modulation depth	Mod Delay	Mod Freq 0.13–1.39Hz
18. Flanger	Flanger with wide sweep range	Pattern 2–16: Variations with different modulation rate 1: 0.76Hz/2–16: 0.1–1.9Hz	Mod Depth	Mod F/B
19. Pitch	Pitch shifter with a range of up to one octave up or down. When changing the pattern, the pitch is shifted along the major scale (*see right page illustration).	Patterns 2–8 are negative pitch shift variations, and patterns 10–16 are positive pitch shift variations. Pattern 9 is a detune effect. 1: +10Cents	Semi Tone Shift	Detune Width Pattern2–8: 0– +13Cent Pattern1,10–16: 0– -7Cent
20. Tremolo	Tremolo with delay and opposite phase for L/R	Pattern 2–16: Variations with different modulation rate 1: 2.54Hz/2–16: 0.14–5.24Hz	Delay Time 11–370mS	Delay F/B
21. ZNR	Zoom noise reduction. Use EDIT 1/2 to adjust the L and R depth of the effect.	Pattern 2–16: Variations with different threshold. Select the pattern which yields the best noise reduction.	Depth-L	Depth-R
22. Cho+Rev	Serial connection of chorus and reverb	Pattern 2–16: Variations with different modulation depth 1: Rev Time = 1.9Sec	Rev Time 0.5–3.3Sec	Rev Mix
23. Fla+Rev	Serial connection of flanger and reverb	Pattern 2–16: Variations with different modulation rate 1: 0.22Hz, Rev Time = 3.1Sec	Rev Time 0.5–3.3Sec	Mod Depth
24. Pit+Rev	Serial connection of pitch shifter and reverb. When changing the pattern, the pitch is shifted along the major scale.	Patterns 2–8 are negative pitch shift variations, and patterns 10–16 are positive pitch shift variations. Pattern 9 is a detune effect. 1: -10Cents, Rev Time = 2.7Sec	Rev Time 0.5–3.3Sec	Rev Mix

* For each effect, pattern 1 is called DEMO (standard setting).

[EDIT 1/2 Parameters]

Mod Delay:	Adjusts the delay until the start of modulation.
Mod Freq:	Adjusts the modulation rate.
Mod Depth:	Adjusts the modulation depth.
Mod F/B:	Adjusts the modulation feedback amount.
Semi Tone Shift:	Adjusts the pitch in semitone steps.
Detune Width:	Pitch fine adjustment. Pitch moves in different directions for left and right channels.
Delay Time:	Adjusts the interval between the original sound and delay sound, and between delay components.
Delay F/B:	Adjusts the delay feedback amount.
Depth L/R:	Adjusts the depth of the ZNR effect.
Rev Time:	Adjusts the reverb time.
Rev Mix:	Controls the volume of the reverb sound only.

ZOOMSTUDIO 1202 EFFECT PROGRAM LIST

BANK B

Effects	Description	Patterns	EDIT 1	EDIT 2
25. Cho/Rev	Parallel effect with chorus in the left channel and reverb in the right channel	Pattern 2–16: Variations with different modulation depth 1: Rev Time = 1.7Sec	Rev Time 0.5–3.3Sec	Rev Mix
26. Fla/Rev	Parallel effect with flanger in the left channel and reverb in the right channel	Pattern 2–16: Variations with different modulation rate 1: 0.76Hz, Rev Time = 2.7Sec	Rev Time 0.5–3.3Sec	Rev Mix
27. Pit/Rev	Parallel effect with pitch shifter in the left channel and reverb in the right channel	Patterns 2–8 are negative pitch shift variations, and patterns 10–16 are positive pitch shift variations. Pattern 9 is a detune effect. 1: +7Semi Tone, Rev Time = 1.9Sec	Rev Time 0.5–3.3Sec	Rev Mix
28. Trem/Rev	Parallel effect with tremolo in the left channel and reverb in the right channel	Pattern 2–16: Variations with different modulation rate 1: 3.5Hz, Rev Time = 0.7Sec	Rev Time 0.5–3.3Sec	Rev Mix
29. Cho/Echo	Parallel effect with chorus in the left channel and echo in the right channel	Pattern 2–16: Variations with different modulation depth 1: Delay Time = 185mS	Delay Time 11–370mS	Echo Mix
30. Fla/Echo	Parallel effect with flanger in the left channel and echo in the right channel	Pattern 2–16: Variations with different modulation rate 1: 0.27Hz, DLY Time = 126mS	Delay Time 11–370mS	Echo Mix
31. Pit/Echo	Parallel effect with pitch shifter in the left channel and echo in the right channel	Patterns 2–8 are negative pitch shift variations, and patterns 10–16 are positive pitch shift variations. Pattern 9 is a detune effect. 1: -5Semi Tone, DLY Time = 150mS	Delay Time 11–370mS	Echo Mix
32. Trem/Echo	Parallel effect with tremolo in the left channel and echo in the right channel	Pattern 2–16: Variations with different modulation rate 1: 4.62Hz, DLY Time = 161mS	Delay Time 11–370mS	Echo Mix

* For each effect, pattern 1 is called DEMO (standard setting).

[EDIT 1/2 Parameters]

Echo Mix: Controls the volume of the echo sound only.

*** Pitch Shift Intervals**



EDIT 1

Pattern = 2 3 4 5 6 7 8 9 10 11 12 13 14 15 16

DRY / Input Notes

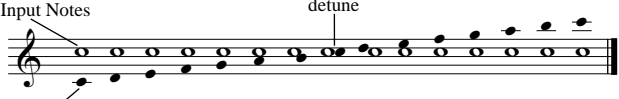

WET / Shifted Notes

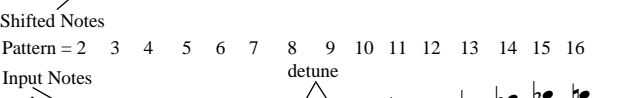

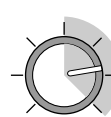

EDIT 1

Pattern = 2 3 4 5 6 7 8 9 10 11 12 13 14 15 16

DRY / Input Notes

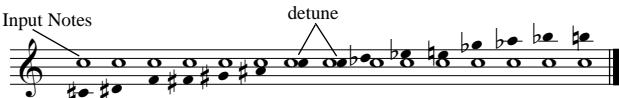

WET / Shifted Notes

