

USAGE AND SAFETY PRECAUTIONS

SAFETY PRECAUTIONS

In this manual, symbols are used to highlight warnings and cautions for you to read so that accidents can be prevented. The meanings of these symbols are as follows:



This symbol indicates explanations about extremely dangerous matters. If users ignore this symbol and handle the device the wrong way, serious injury or death could result.



This symbol indicates explanations about dangerous matters. If users ignore this symbol and handle the device the wrong way, bodily injury and damage to the equipment could result.

Please observe the following safety tips and precautions to ensure hazard-free use of the RT-223.

• Power requirements



Since power consumption of this unit is fairly high, we recommend the use of an AC adapter whenever possible. When powering the unit from batteries, use only alkaline types.

[AC adapter operation]

- Be sure to use only an AC adapter which supplies 9 V DC, 300 mA and is equipped with a "center minus" plug (Zoom AD-0006). The use of an adapter other than the specified type may damage the unit and pose a safety hazard.
- Connect the AC adapter only to an AC outlet that supplies the rated voltage required by the adapter.
- When disconnecting the AC adapter from the AC outlet, always grasp the adapter itself and do not pull at the cable.
- During lightning or when not using the unit for an extended period, disconnect the AC adapter from the AC outlet.

[Battery operation]

- Use four conventional IEC R6 (size AA) batteries (alkaline).
- The RT-223 cannot be used for recharging.
- Pay close attention to the labelling of the battery to make sure you choose the correct type.
- When not using the unit for an extended period, remove the batteries from the unit.
- If battery leakage has occurred, wipe the battery compartment and the battery terminals carefully to remove all remnants of battery fluid.
- While using the unit, the battery compartment cover should be closed.

• Environment



To prevent the risk of fire, electric shock or malfunction, avoid using your RT-223 in environments where it will be exposed to:

- Extreme temperatures
- Heat sources such as radiators or stoves
- High humidity or moisture

- Excessive dust or sand
- Excessive vibration or shock

• Handling



- Never place objects filled with liquids, such as vases, on the RT-223 since this can cause electric shock.
- Do not place naked flame sources, such as lighted candles, on the RT-223 since this can cause fire.



The RT-223 is a precision instrument. Do not exert undue pressure on the keys and other controls. Also take care not to drop the unit, and do not subject it to shock or excessive pressure.

• Connecting cables and input and output jacks



You should always turn off the power to the RT-223 and all other equipment before connecting or disconnecting any cables. Also make sure to disconnect all connection cables and the power cord before moving the RT-223.

• Alterations



Never open the case of the RT-223 or attempt to modify the product in any way since this can result in damage to the unit.

• Volume



Do not use the RT-223 at a loud volume for a long time since this can cause hearing impairment.

Usage Precautions

• Electrical interference

For safety considerations, the RT-223 has been designed to provide maximum protection against the emission of electromagnetic radiation from inside the device, and protection from external interference. However, equipment that is very susceptible to interference or that emits powerful electromagnetic waves should not be placed near the RT-223, as the possibility of interference cannot be ruled out entirely.

With any type of digital control device, the RT-223 included, electromagnetic interference can cause malfunctioning and can corrupt or destroy data. Care should be taken to minimize the risk of damage.

• Cleaning

Use a soft, dry cloth to clean the RT-223. If necessary, slightly moisten the cloth. Do not use abrasive cleanser, wax, or solvents (such as paint thinner or cleaning alcohol), since these may dull the finish or damage the surface.

Please keep this manual in a convenient place for future reference.

* MIDI is a registered trademark of Association of Musical Electronics Industry(AMEI).

* SD Logo is a trademark.

* All trademarks and registered trademarks mentioned in this manual are for identification purposes only and are not intended to infringe on the copyrighted properties of their respective owners.

Contents

USAGE AND SAFETY PRECAUTIONS . . . 2	
SAFETY PRECAUTIONS 2	
Usage Precautions 2	
Introduction 4	
Names of Parts 5	
Top panel 5	
Rear panel 5	
Getting Connected 6	
Using the Unit on Batteries 7	
Preparations 7	
Quick Guide 8	
Quick Guide 1 Listening to the Demo Song . . 8	
Quick Guide 2 Playing the Pads 10	
Quick Guide 3 Playing a Pattern 12	
Quick Guide 4 Assembling a Song by Hitting the Pads 14	
Quick Guide 5 Using Groove Play 16	
Playing the Pads (Manual Play) 18	
Playing by tapping the pads 18	
Selecting a kit/program 19	
Playing the Patterns (Pattern Mode) . . 20	
Playing a pattern 20	
Changing the tempo of pattern playback . . 21	
Entering Patterns in Real Time 22	
Real-time recording of a drum track 22	
Real-time recording of a bass track 25	
Entering Patterns Using Step Input . . 27	
What is step recording? 27	
Step recording of drum track 28	
Step recording of bass track 29	
Editing a Pattern 32	
Copying a pattern/Returning a pattern to the factory default condition 32	
Erasing a pattern 33	
Assigning a name to a pattern 33	
Creating Songs (Song Mode) 34	
What is a song? 34	
Creating a song using step input 34	
Creating a song using real-time input 36	
Creating a song using FAST input 39	
Entering event information 42	
Playing a song 44	
Editing a Song 45	
Copying a range of measures 45	
Copying a song 46	
Erasing a song 47	
Assigning a name to a song 47	
Using Pads to Play Patterns (Groove Play Mode) 48	
Various Drum Kit Functions (Kit Mode) 50	
Creating an original drum kit 50	
Copying a drum kit/Returning a drum kit to the factory default condition 52	
Assigning a name to a drum kit 53	
Using Effects (Effect Mode) 54	
About the effects 54	
About patches 54	
Using the COMP EQ effect 55	
Using the REVERB effect 55	
Editing effect patches 57	
Storing, swapping, or initializing effect patches 58	
Assigning a name to an effect patch 59	
Using the Metronome (Metronome Mode) 60	
Changing Various Settings of the RT-223 63	
Basic function setting procedure 63	
Function setting items 64	
Other Functions 68	
Using the jam function 68	
Synchronizing the RT-223 to external MIDI equipment 69	
Using MIDI equipment to play the RT-223 . . 70	
Checking the remaining memory capacity 71	
Turning the backlight off 71	
Returning the RT-223 to the factory default condition (initialization) 71	
Troubleshooting 72	
RT-223 Appendix 73	
RT-223 Product Specifications 73	
Reverb Module 74	
COMP EQ Module 75	
PATCH LIST 76	
DRUM KIT LIST 77	
BASS PROGRAM LIST 78	
DRUM PAD NOTE# LIST 78	
MIDI NOTE # LIST 78	
INSTRUMENT LIST 79	
PRESET PATTERN LIST 80	
PRESET SONG PAD PARAMETER 85	
MIDI Implementation 86	
MIDI Implementation Chart 87	

Introduction

Thank you for selecting the *ZOOM RhythmTrak RT-223* (hereafter simply called the “*RT-223*”). The RT-223 is a sophisticated product with the following features.

- **Highly compact drum/bass machine**

The RT-223 is small enough to fit in the pocket of a guitar case. But it has enough muscle to play a full rhythm accompaniment with super realistic drum and bass sounds. You can use it as a personal metronome during practice, or as your rhythm section during a live performance and when making a demo tape.

- **Perfectly simple operation**

Even if you have never used a drum machine or sequencer before, you will feel comfortable with the RT-223 right away.

- **Great selection of preset patterns**

The RT-223 can store 511 different patterns (including patterns that you have created yourself). Out of the box, it comes with a wide choice of representative patterns that will you get started in no time.

- **Program the accompaniment to an entire song**

You can line up multiple patterns in the intended order to create the rhythm accompaniment for a full song. Besides step input, where you specify elements such as pattern number, volume, and tempo one by one, the RT-223 also supports the innovative FAST input method developed by ZOOM.

- **Groove play mode lets you play patterns like a DJ**

Assigning patterns to the pads on the top panel lets you change patterns simply by tapping the pads. Great for live performances and for DJ use.

- **Create your original kits**

The RT-223 comes with built-in drum kits and bass programs for a variety of musical genres. What’s more, you can create your own drum kits by combining drum sounds at will.

- **Two types of effects**

The drum kit/bass program sound can be processed by two kinds of effects (COMP EQ and REVERB). The REVERB effect allows adjusting

the effect depth for each drum sound individually.

- **Jam function for selecting patterns with a foot switch**

Connect a foot switch to have even more control over play start/stop and switching patterns. While playing your instrument, you can set fill-ins or breaks or return to the main theme after improvising for any length. This is great for those lively jam sessions.

- **Built-in metronome function**

The metronome is convenient for scale practice or rhythm practice. In addition to the standard beat, you can also use mixed beat settings such as 5-beat and 7-beat.

- **Input jack for connecting an external sound source**

Connect an instrument processed with a multi-effect such as the ZOOM GFX-1 and mix it with the RT-223 signal to produce impressive sounding output.

- **Control various functions with a foot switch**

A connected foot switch can be used to start/stop a pattern or change the tempo while keeping your hands free. Alternatively, push the foot switch down to kick a virtual bass drum, or switch between hi-hat open/close.

- **Compatible with MIDI synchronization**

The MIDI IN connector allows an external MIDI keyboard or other device to play the sounds of the RT-223. It is also possible to synchronize the RT-223 to the MIDI clock from a MIDI sequencer.

Please take the time to read this manual carefully so as to get the most out of your RT-223 and to ensure optimum performance and reliability. Retain this manual, the warranty card and all other documentation for future reference.

Names of Parts

Top panel

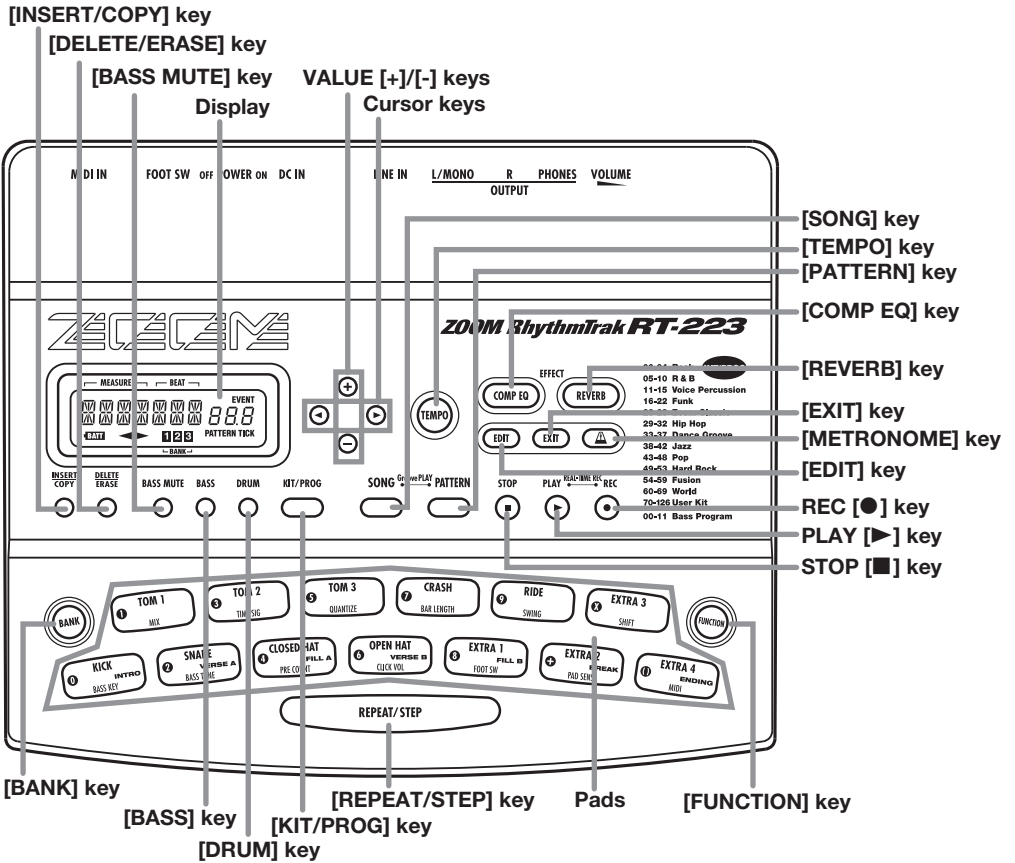

Rear panel

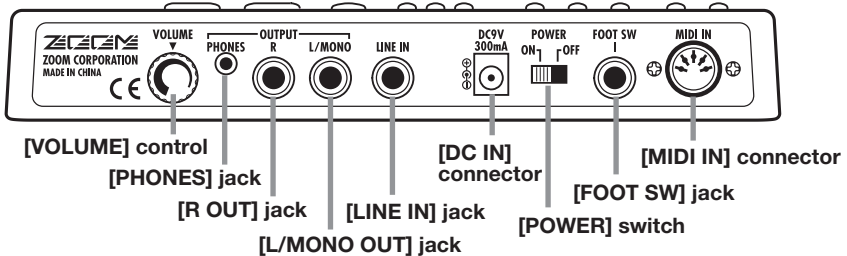

Getting Connected

For mono playback, connect only the [L/MONO OUT] jack.

Connecting the optional foot switch FS01 allows such functions as playing the bass drum sound with your foot or switching between open and closed hi-hat.

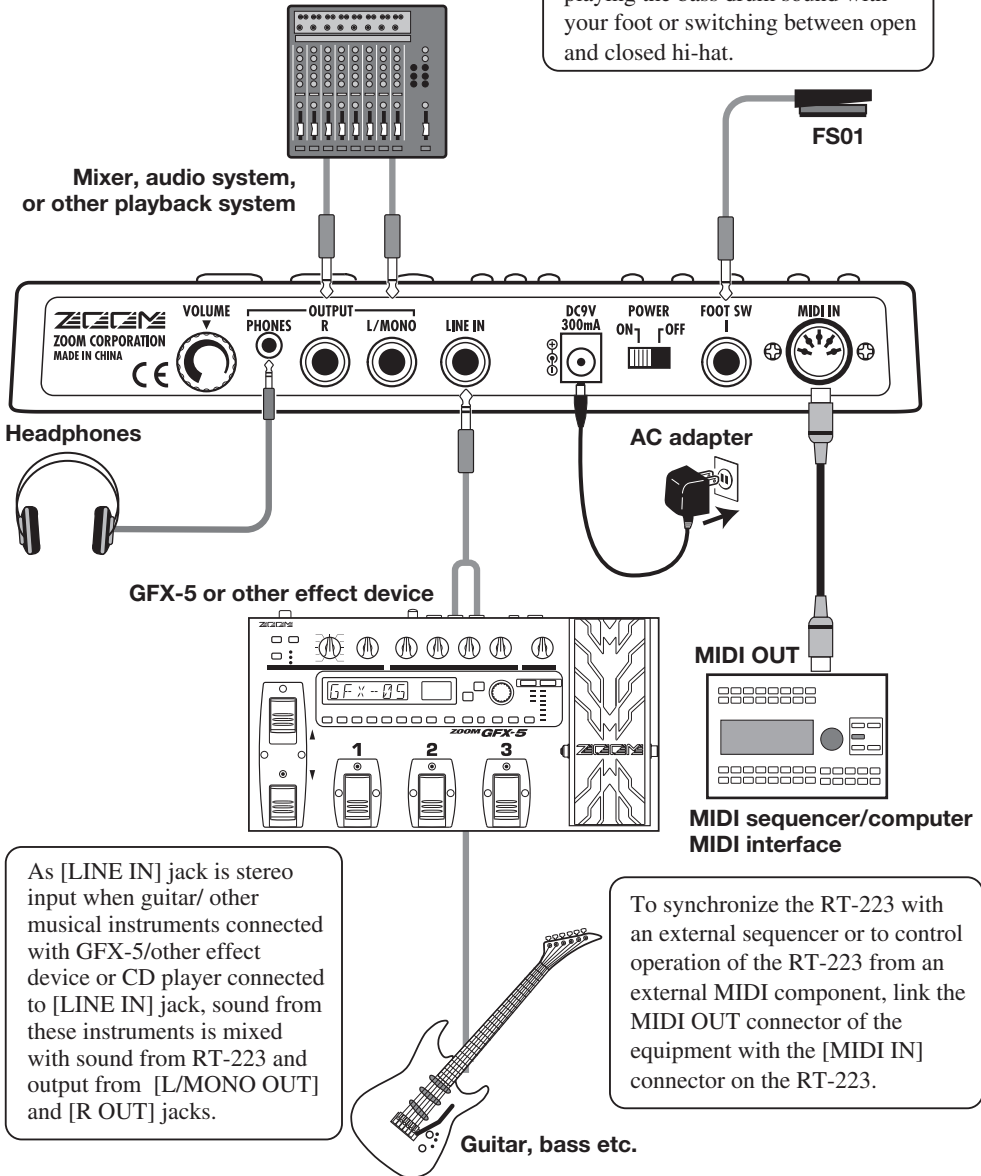

As [LINE IN] jack is stereo input when guitar/ other musical instruments connected with GFX-5/other effect device or CD player connected to [LINE IN] jack, sound from these instruments is mixed with sound from RT-223 and output from [L/MONO OUT] and [R OUT] jacks.

To synchronize the RT-223 with an external sequencer or to control operation of the RT-223 from an external MIDI component, link the MIDI OUT connector of the equipment with the [MIDI IN] connector on the RT-223.

Using the Unit on Batteries

The RT-223 can be powered from four IEC R6 (size AA) batteries. Follow the steps below to insert the batteries.

1. Turn the unit over and open the battery compartment cover.
2. Insert four fresh IEC R6 (size AA) alkaline batteries.
3. Close the battery compartment cover.

NOTE

If the "BATT" symbol appears while the unit is powered from batteries, the batteries are exhausted. Replace the batteries as soon as possible.

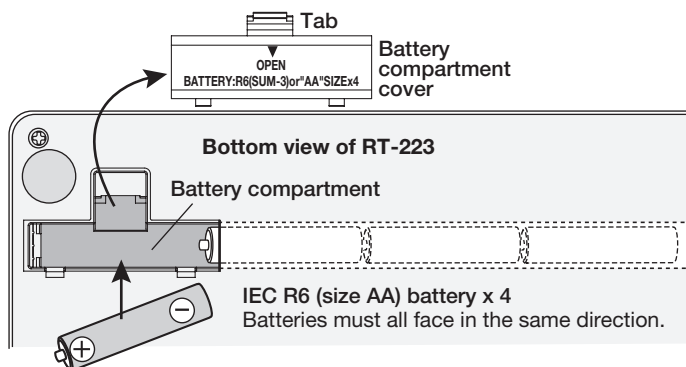

Preparations

After connections are established, check the sound by performing the following steps.

1. With the playback system turned off and the volume fully turned down, double-check whether all connections have been made correctly.
3. Set the [POWER] switch of the RT-223 to ON, and then turn power to the playback system on.

2. To power the unit from the AC adapter(optional),connect the AC adapter to the [DC IN] connector and turn the [VOLUME] control fully down.



4. While tapping a pad to produce sound, adjust the [VOLUME] control of the RT-223 and the volume control on the playback system to a suitable position.



This Quick Guide demonstrates how to operate your RT-223, using a few representative examples. Some of the terms and concepts used in this manual are also explained here.

Quick Guide 1 Listening to the Demo Song

The RT-223 comes with a demo song already built in. Hear for yourself what RT-223 can do.

1 Connect the RT-223 to the playback system and turn the power on.

2 Press the [FUNCTION] key.

Verify that the [FUNCTION] key flashes.

3 Press the [SONG] key.

The demo song starts.

Sounds just like the backup of a live band, doesn't it? Note how effectively various drum, percussion, and bass sounds are combined. The RT-223 can produce such a great variety of sounds with ease.

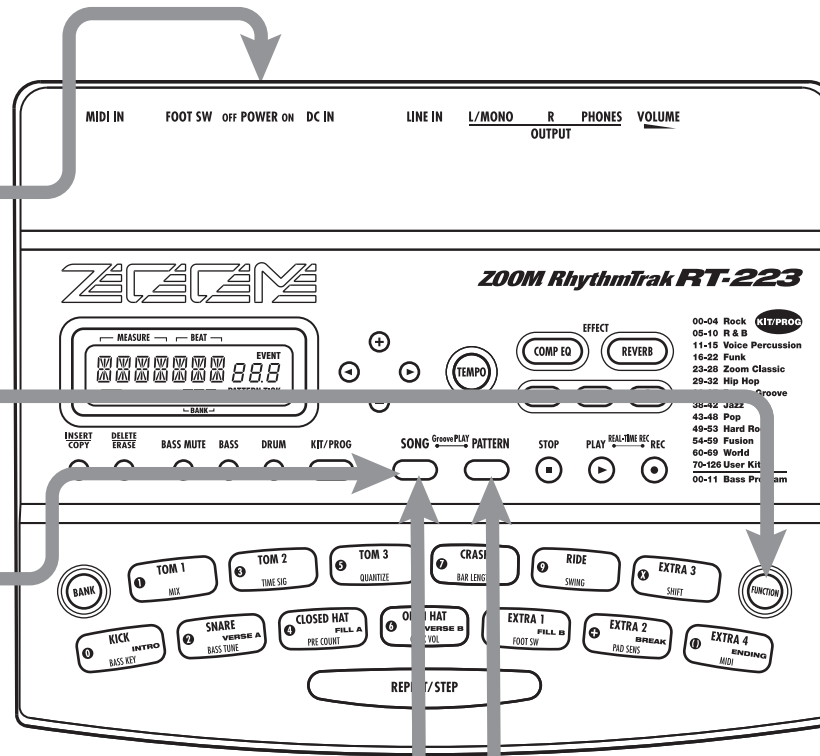

Drum kits and bass programs

The backup sound provided by the RT-223 consists of a drum kit and a bass program. A drum kit is a collection of drum sounds including bass drum, snares, and tomtom, percussion sounds such as congas and bongos, and various other effect sounds. These are combined to create backing tracks for a wide range of music genres. The RT-223 comes with 127 drum kits of which 70 are preprogrammed. You can also create your own original drum kits.

A bass program is a bass sound such as electric bass, acoustic bass, or synthesizer bass. 12 types of bass programs are available, of which one can be selected for playback.

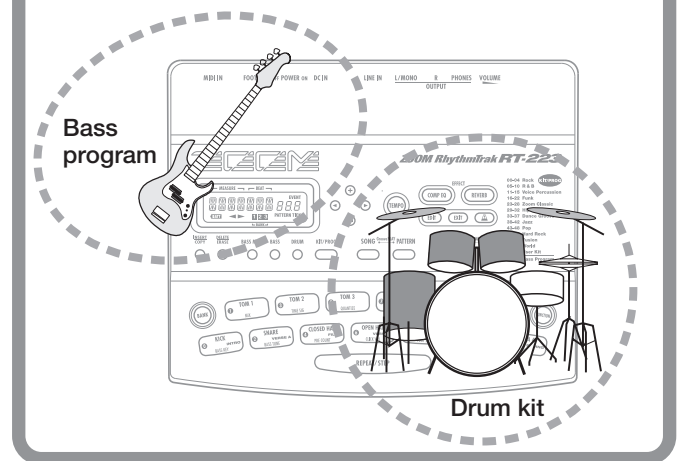

To stop the demo

4 Press the [PATTERN] key or [SONG] key.

When [PATTERN] key is pressed RT-223 switches to pattern mode (for playing and recording patterns).

When [SONG] key is pressed RT-223 switches to song mode (for creating backing songs which are sequences of patterns).

Quick Guide 2 Playing the Pads

The top panel of the RT-223 has 13 pads which serve to play drum kits and bass programs.

1 Turn the power on.

2 Press the [PATTERN] key.

The [PATTERN] key lights up and the RT-223 is in pattern mode.

3 Press the [DRUM] key.

The [DRUM] key lights up. Now you can use the pads to play the drum kit.

4 Tap the pads.

You will notice that the pads produce various drum sounds. The 13 pads are assigned different sounds, depending on the drum kit or bass program that has been selected. The illustration below shows an example for the drum sounds of the 13 pads with a drum kit.

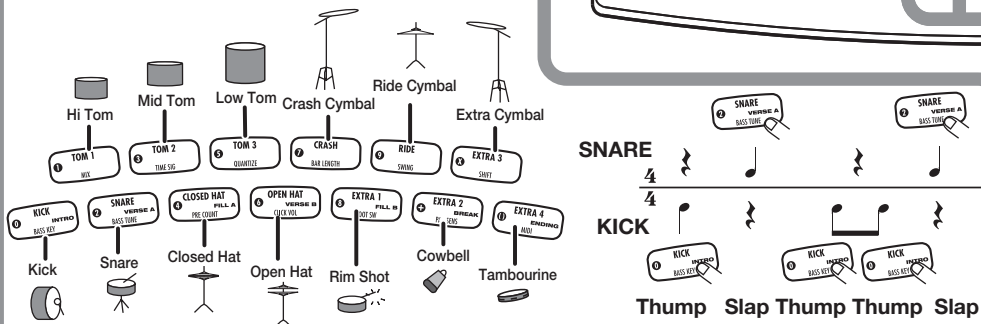

Try tapping pad 0 (KICK) and pad 2 (SNARE) as shown in the illustration above, to play a rhythm line of bass drum and snare drum.

To play a bass program with the pads

5 Press the [BASS] key.

The [BASS] key lights up and the current bass program can be played with the pads.

You will notice that different pads produce bass sound of a different pitch. You can use the 13 pads like the keys of a keyboard.

The illustration below shows an example for the notes produced by the pads when a bass program is selected.

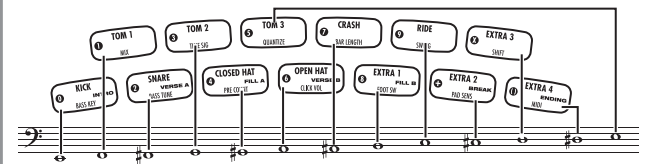

To change the drum kit/bass program

6 Press the [DRUM] or [BASS] key and then the [KIT/PROG] key.

When you press the [KIT/PROG] key, the display shows the name of the currently selected drum kit or bass program.

7 Press one of the VALUE [+]/[-] keys.

VALUE [+] key

Selects the next higher kit/program number.

VALUE [-] key

Selects the next lower kit/program number.

8 Press the [EXIT] key.

To play the changed drum kit/bass program with the pads, press the [EXIT] key to return to the pattern mode.



Quick Guide 3 Playing a Pattern

The RT-223 already contains many preprogrammed patterns (backing sequence of several bars), using the drum kits and bass programs. Here's how you can play such a pattern.

1 Turn the power on.

2 Press the [PATTERN] key.

The [PATTERN] key lights up and the RT-223 is in pattern mode. The display shows the currently selected pattern name and pattern number.



Pattern name Pattern number

3 Press the PLAY [▶] key.

Playback of the currently selected pattern starts. The patterns of the RT-223 can be thought of as "recordings" of a drum kit and bass program. These are recorded on so-called tracks that are combined to form the pattern.

A pattern of the RT-223 therefore consists of the drum track and the bass track. The drum track contains a drum kit recording and the bass track a bass program recording.

Pattern

Drum track

Bass track

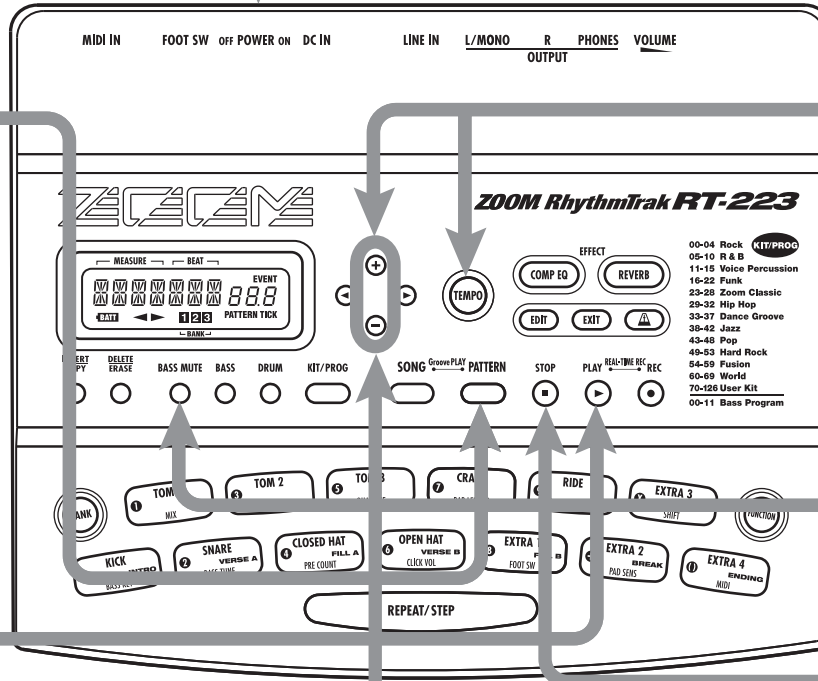

To change the pattern

4 Press one of the VALUE [+]/[-] keys.

VALUE [+] key

Increases the tempo value.

VALUE [-] key

Decreases the tempo value.



Pattern name Pattern number

To change the tempo

5 Hold the [TEMPO] key...

While the [TEMPO] key is held down, the display shows the currently active tempo.

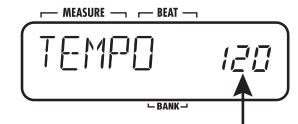

Tempo value (BPM)

Press one of the VALUE [+]/[-] keys.

VALUE [+] key

Increases the tempo value.



VALUE [-] key

Decreases the tempo value.

HINT

You can tap the [TEMPO] key twice in succession to specify the tempo (→ p. 21).

To mute the bass sound

6 Press the [BASS MUTE] key once.

Press the key once more to turn the bass on again.

To stop pattern play

7 Press the STOP [■] key.

Quick Guide 4 Assembling a Song by Hitting the Pads

In song mode, you can preassign patterns to pads, making it easy to switch patterns by hitting the pads. This function lets you assemble patterns for a song in real time, complete with fill-ins and breaks.

1 Turn power on.

2 Press the [SONG] key.

The [SONG] key lights up and the RT-223 goes into song mode. The display shows the name and number of the currently selected song.

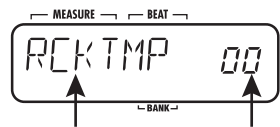

Song name Song number

3 Use the VALUE [+]/[-] keys to select a song.

In this example, select a song from numbers 0 -9.

VALUE [+] key

Select next higher song number.

VALUE [-] key

Select next lower song number.

For these preprogrammed songs numbers, patterns are already assigned to the pads.

4 Press pad 0



When you hit pad 0 (INTRO), the intro pattern plays, and then the RT-223 automatically switches to pad 2 (VERSE A).

5 Press pads 1 - 9, [+], [x].

The respective patterns assigned to the pads will play. When pad 4 (FILL A), pad 8 (FILL B), or pad [+] (BREAK) is pressed, the fill-in or break pattern plays, and then the RT-223 switches automatically to the pattern of another pad. When you press one of these pads, a new pattern will start playing at the beat, even if the previous pattern is not finished. (For other pads, the pattern is switched only after the current pattern has finished.)

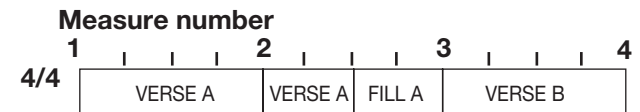

For most of the songs 0 - 9, patterns are assigned to the pads as follows.

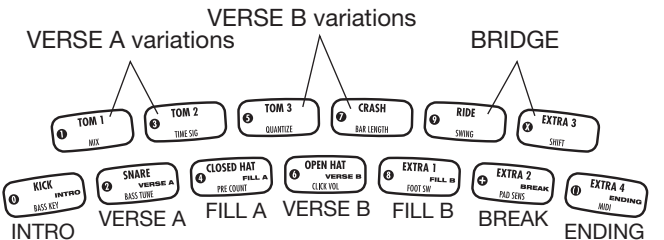

6 Press pad [0].



When you hit pad [0] (ENDING), the ending pattern plays, and then the RT-223 automatically stops playing.

In this way, you can assemble the accompaniment for an entire song in real time.

HINT You can also record your pad playing in the song (→ p. 36). The assignment of patterns to pads and the transition settings can be changed (→ p. 37).

Quick Guide 5 Using Groove Play

Groove play is a special feature of the RT-223 which lets you switch among various patterns simply by tapping the pads. This makes it easy to play with patterns like a DJ spinning records.

1 Turn the power on.

2 Press the [SONG] key and [PATTERN] key together.
 The [SONG] key and [PATTERN] key light up, and the RT-223 is in groove play mode.

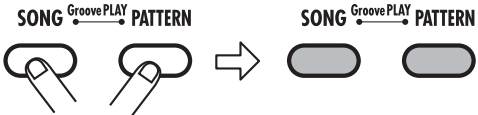

3 Push a pad.
 While the pad is held down, the pattern assigned to that pad is played. Give it a try and check out which patterns are assigned to the various pads.

HINT The pattern assigned to a pad can be changed (→ p. 48).

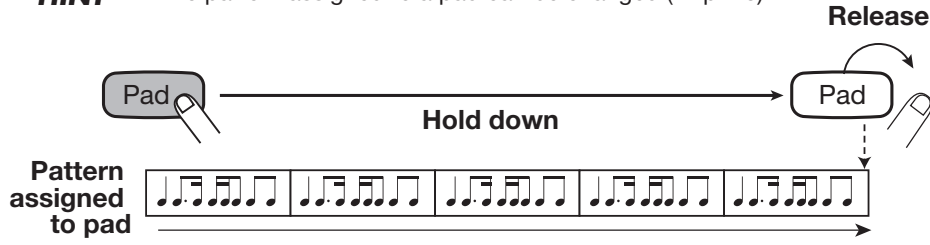

To play multiple patterns simultaneously

5 Push several pads together.
 In groove play mode, up to 4 patterns can be played simultaneously. While playing a basic drum pattern, you can do things such as hitting another pad to overlay a bass pattern and then adding a snare fill-in. By using the right timing when pushing the pads, you can create complex rhythms.

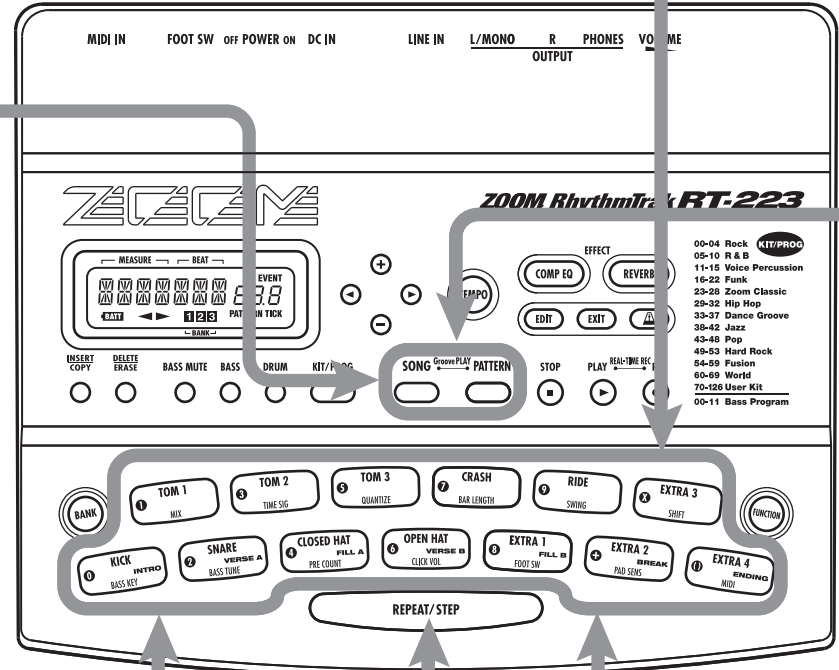

To stop groove play

6 Press the [SONG] key or [PATTERN] key.

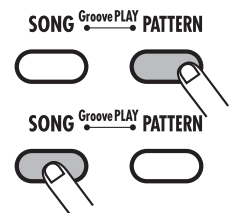

RT-223 switches to pattern mode.

RT-223 switches to song mode.

To keep playing the pattern without pressing the pad

4 Hold down the [REPEAT/STEP] key while pushing the pad.
 The pattern will continue to play when the pad is released. This is useful to keep on playing a basic drum pattern.

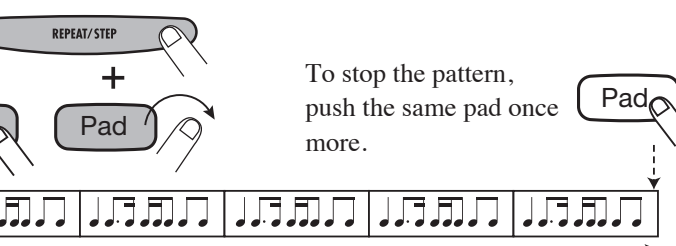

Release

Pad

Pad

Pad

Pattern assigned to pad

To stop the pattern, push the same pad once more.

Playing the Pads (Manual Play)

The RT-223 lets you not only play back existing patterns and songs, it also allows you to manually play the unit by tapping the pads. This section describes how to manually play the unit.

Playing by tapping the pads

The RT-223 assigns various sounds or pitches to the pads, depending on the currently selected drum kit/bass program. Play the pads to discover the realistic sounds offered by the RT-223.

1. Press the [PATTERN] key.



This activates the pattern mode. The [PATTERN] key lights up.

2. Press the [DRUM] key.

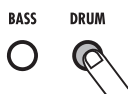

The [DRUM] key lights up, and you can play the drum kit using the pads.

During manual play, you use the [DRUM] key and [BASS] key to select the drum kit or bass program. (The selected key lights up.)

3. Tap one of the pads.



The LED of the pad lights up briefly and the sound assigned in the drum kit to that pad is heard. The volume changes according to how strongly you tap the pad.

HINT

When the [BASS] key is pressed in step 2, a bass program can be played, but there is a difference in how the pads operate. With a drum kit, the sound plays through even if the pad is released immediately. With a bass program, the sound continues only as long as the pad is pressed.

4. Press the [BANK] key.



Each time you press the [BANK] key, the set of sounds assigned to the pads (pad bank) changes. The RT-223 gives you a choice of three pad banks.

HINT

When a bass program is selected, pressing the [BANK] key changes the pitch range of the bass sound.

5. To play the sound of a pad repeatedly, hold down the [REPEAT/STEP] key while pushing the pad.



The sound will be repeated while the pad is being held down. The repeat rate depends on the tempo setting.

HINT

The repeat play interval can be adjusted with the quantize setting (→ p. 65).

Selecting a kit/program

The RT-223 lets you select among 127 drum kits (70 preprogrammed) and 12 bass programs. Try changing the setting as follows.

1. Press the [PATTERN] key.



The [PATTERN] key lights up and the RT-223 goes into pattern mode.

2. Press the [DRUM] key/[BASS] key and then the [KIT/PROG] key.



The name and number of the currently selected drum kit (or bass program) appears on the display.



HINT

Available drum kit types are printed on the panel.

00-04	Rock	KIT/PROG
05-10	R & B	
11-15	Voice Percussion	
16-22	Funk	
23-28	Zoom Classic	
29-32	Hip Hop	
33-37	Dance Groove	
38-42	Jazz	
43-48	Pop	
49-53	Hard Rock	
54-59	Fusion	
60-69	World	
70-126	User Kit	
00-11	Bass Program	

3. Use the VALUE [+]/[-] keys to select the drum kit/bass program.



The kit/program number shown on the display increases or decreases by one, and the kit/program is switched accordingly.



HINT

- Keeping a VALUE [+]/[-] key depressed changes numbers continuously.
- To change numbers quickly, hold down one of the VALUE [+]/[-] keys and press the other key. The numbers will change rapidly.

4. Press the [PATTERN] key to return to pattern mode.

You can now play the sound of the new drum kit/bass program with the pads.

Playing the Patterns (Pattern Mode)

This section describes how to play patterns of the RT-223.

Playing a pattern

The RT-223 incorporates 511 accompaniment patterns. In the factory default condition, the patterns 0 - 439 are preprogrammed.

1. Press the [PATTERN] key.

The [PATTERN] key lights up and the RT-223 goes into pattern mode. The name and number of the currently selected pattern appears on the display.

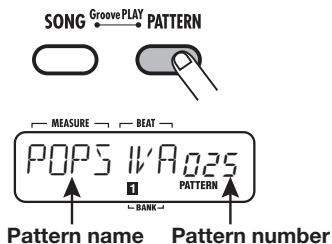

2. Use the VALUE [+]/[-] keys to select the pattern to play.



3. Press the PLAY [▶] key.



The PLAY [▶] key lights up and the pattern is played repeatedly.

The [TEMPO] key flashes according to the tempo of the pattern.

The display shows the current position in the pattern (measure/beat).

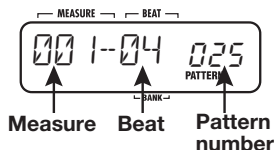

HINT

- You can use the pads for manual play while a pattern is playing.
- You can switch the pattern number while a pattern is playing.

4. To mute only the bass track, press the [BASS MUTE] key.



The key lights up and the bass track is muted (only the drum track is heard). To turn the bass track back on, press the [BASS MUTE] key once more.

HINT

The bass track can be muted while the pattern is stopped.

5. Press the STOP [■] key to stop the pattern.



Pressing the PLAY [▶] key instead of the STOP

[■] key sets the unit to pause mode. The PLAY [▶] key flashes. Pressing the PLAY [▶] key again in this condition resumes playback from the point where it was paused.

Changing the tempo of pattern playback

When playing a pattern in pattern mode, the playback tempo for the pattern can be varied over the range of 40 - 250 BPM (BPM = beats per minute, using quarter notes).

1. Press the [TEMPO] key.

The display shows the current tempo for about 2 seconds.

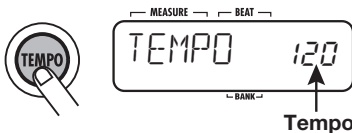

2. Use the VALUE [+]/[-] keys to set the tempo.

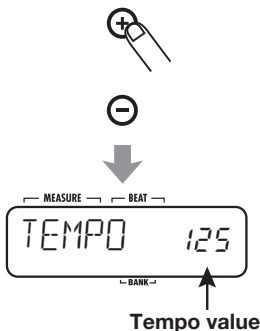

To return to the condition before the [TEMPO] key was pressed, press the [EXIT] key or simply wait a while.

3. To set the tempo directly by manual input, tap the [TEMPO] key twice while the indication "TEMPO" is shown on the display (tap tempo input function).



While the pattern is stopped or playing, pressing the [TEMPO] key once to bring up the "TEMPO" indication, and then pressing the [TEMPO] key twice in succession will set the tempo by taking the key press interval as a quarter note. Simply tap the [TEMPO] key in sync with the song rhythm.

NOTE

The tempo set in pattern mode applies to all patterns.

Entering Patterns in Real Time

The RT-223 lets you enter your own accompaniment patterns. Creating and recording a pattern is possible in two ways: by actually playing the pattern on the pads (real-time recording), or by entering each sound individually (step recording). The procedure for real-time recording of a drum track and bass track is described below.

Real-time recording of a drum track

To record a drum track in real time using the pads, proceed as follows.

1. Press the [PATTERN] key.



The [PATTERN] key lights up and the RT-223 goes into pattern mode. The name and number of the currently selected pattern appear on the display.

2. Use the VALUE [+]/[-] keys to select an empty pattern.

When you select an empty pattern, the indication "EMPTY" appears on the display.

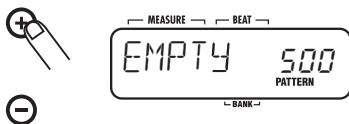

HINT

If there is no empty pattern, you should delete an unwanted pattern (→p.33).

3. Press the [DRUM] key.

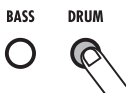

The [DRUM] key and [BASS] key serve to select the drum track or bass track.

4. Press the [KIT/PROG] key.

The name and number of the currently selected drum kit appears on the display.

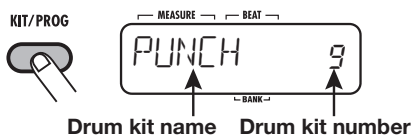

5. Use the VALUE [+]/[-] keys to select a drum kit.



HINT

- Keeping a VALUE [+]/[-] key depressed changes numbers continuously.
- To change numbers quickly, hold down one of the VALUE [+]/[-] keys and press the other key. The numbers will change rapidly.
- The drum kit/bass program used for a pattern can be changed later, after the pattern has been recorded.
- When you change the drum kit/bass program of a pattern, the new drum kit/bass program is automatically stored for that pattern.

6. Press the [EXIT] key to return to pattern mode.

The sound of the newly selected drum kit can now be played in pattern mode.

7. Press the [FUNCTION] key and then pad 5 (QUANTIZE).

The current quantize value appears on the display.

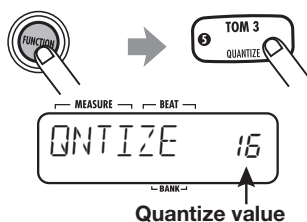

“Quantization” refers to the degree of detail with which notes are recorded. By setting the quantize value to the shortest note to use for the pattern, recording can be carried out while automatically maintaining precise timing. If you select the finest quantize setting, you can retain the human touch that is characterized by slightly irregular timing.

HINT

The [FUNCTION] key is used to make various settings for the RT-223. For details, please refer to page 63.

8. Use the VALUE [+]/[-] keys to set the quantize value (shortest note to be recorded).

- | | |
|-----------------------------|---------------------------------------|
| 4Quarter note | 24.....Sixteenth triplet note |
| 8Eighth note | 32.....Thirty-second note |
| 12Eighth triplet note | 48.....Thirty-second triplet note |
| 16Sixteenth note | Hi1 tick (1/96 of quarter note) |

9. Press the [FUNCTION] key once more.

The new quantize value is set and the unit returns to the pattern mode.

HINT

After recording is completed, it is possible to change the quantize value and record again on the same track. After recording

bass drum and snare drum using quarter notes, you can record a hi-hat sequence with sixteenth notes.

10. While holding down the REC [●] key, press the PLAY [▶] key.

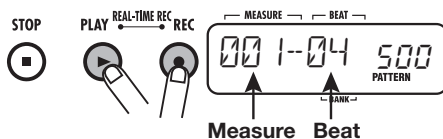

The REC [●] key and PLAY [▶] key light up, and the [TEMPO] key flashes according to the currently selected tempo. The metronome sound starts.

HINT

When you call up an empty pattern, it will be set to the same beat and number of measures as the previous pattern. These settings can be changed, as described on pages 64, 65.

11. Tap the pads in accordance with the metronome sound.



The sound of the respective pad is heard, and it is recorded for the duration set with the quantize value. When the end of the pattern is reached, the recording loops back to the beginning and continues, allowing you to add to the recording as often as desired. You can check the current position in the pattern on the display (measure/beat).

HINT

- By using the [BANK] key during input of a pattern, you can switch the set of drum sounds assigned to the pads.
- When the REC [●] key is pressed during

real-time recording, the REC [●] key starts to flash and pattern recording is suspended. In this condition, tapping the pads will produce sound, but it is not recorded. This is useful to check phrasing and sound before actually recording. To resume recording, press the REC [●] key once more.

12. To erase the sound from a specific pad, push the pad while holding down the [DELETE/ERASE] key.

While the key is held down, the sound from that pad is erased from the pattern, as shown in Figure 1 below.

To erase the entire track, push the [DRUM] key while holding down the [DELETE/ERASE] key. While both keys are held down, all sounds in that track are erased, as shown in Figure 2 below.

13. To repeat a sound, tap the pad while holding down the [REPEAT/STEP] key.

By holding down the [REPEAT/STEP] key while hitting a pad, a percussion sound can be recorded.



14. When real-time input of the drum track is completed, press the STOP [■] key.



Pattern recording stops.

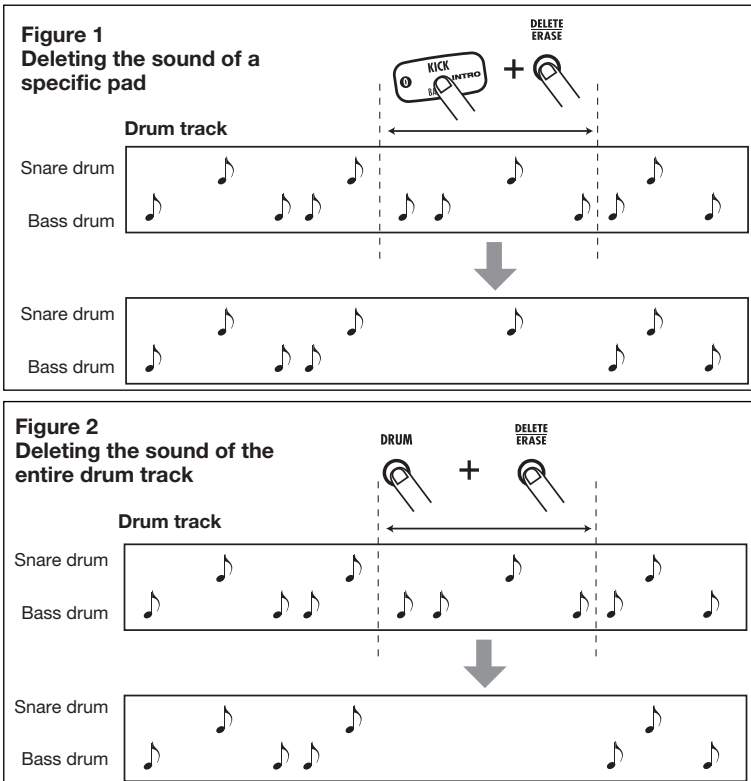

NOTE

- If a MIDI clock signal is being received, real-time recording is not possible. For details, please refer to page 67.

Real-time recording of a bass track

Next, let's add a bass track to the drum track pattern recorded in the previous section.

1. Press the [BASS] key.

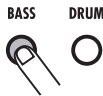

The bass track is selected for recording.

2. Press the [KIT/PROG] key, and then use the VALUE [+]/[-] keys to select the bass program.

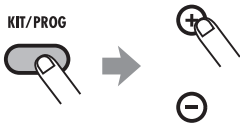

3. Press the [EXIT] key to return to pattern mode.

The sound of the newly selected bass program can now be played in pattern mode.

4. Press the [FUNCTION] key and then pad 0 (BASS KEY).

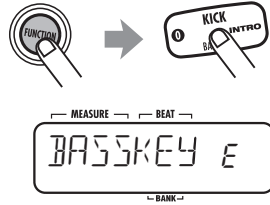

When the bass track is selected, the pads play a series of pitches that are a semitone apart, such as C, C#, D, D#, ...B, C. You can change the bass key that is assigned to the lowest pad (pad 0), as shown in the illustration below.

HINT

The last selected key will be saved as the root for that pattern. By specifying root information in song mode, the bass track can be shifted up or down, using this key as reference.

5. Use the VALUE [+]/[-] keys to select the key to be assigned to pad 0.

HINT

The BASS KEY setting is stored individually for each pattern.

6. When the setting is complete, press the [FUNCTION] key once more.

The [FUNCTION] key goes out and the unit returns to the pattern mode.

Example for BASS KEY setting of "E"

7. While holding down the REC [●] key, press the PLAY [▶] key.

The REC [●] key and PLAY [▶] key light up, and the [TEMPO] key flashes according to the currently selected tempo. The metronome sound starts.

8. Tap the pads along with the metronome sound. Select the pad with the pitch to enter into the phrase.

Unlike in drum track recording, the bass track also records the duration for which you press a pad. For example, to record the following sequence, hold the pad to which A2 has been assigned and the pad to which E2 has been assigned down for the length of a quarter note each.

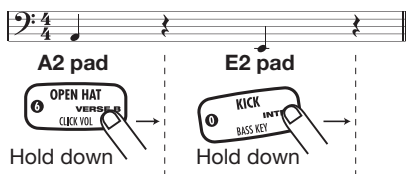

HINT

- By using the [BANK] key during pattern recording, you can switch the pitch range of bass notes assigned to the pads.
- When the REC [●] key is pressed during real-time recording, the REC [●] key starts to flash and pattern recording is suspended. In this condition, tapping the pads will produce sound, but it is not recorded. This is useful to check phrasing before actually recording. To resume recording, press the REC [●] key once more.

9. To erase the sound from a specific pad, push the pad while holding down the [DELETE/ERASE] key.

While the key is held down, the sound from that pad is erased from the pattern.

To erase the entire bass track, push the [BASS] key while holding the [DELETE/ERASE] key down. While both keys are held down, the bass track is erased.

Erasing the sound of a specific pad

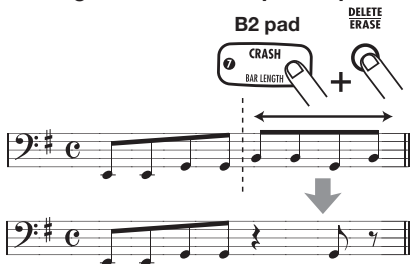

Erasing the sound of the entire bass track

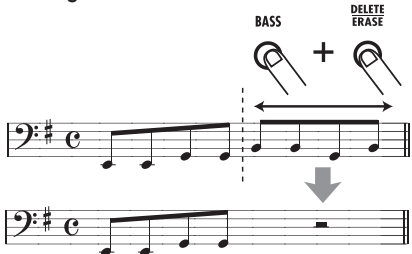

10. When real-time input of the bass track is completed, press the STOP [■] key.

HINT

If necessary, specify a root for the pattern that suits the entered bass phrase. The BASS KEY setting (p. 64) is used to set the root information for the pattern. For patterns that are not to be used in a song or for patterns where the bass track is empty, making the setting is not required.

Step recording of drum track

This section describes how to record the drum track using step recording.

1. In pattern mode, select an empty user pattern, and select a drum kit, as necessary.

The selection method for pattern and drum kit is the same as in real-time recording (→ p. 22). When you select an empty pattern, the indication “EMPTY” appears on the display.

HINT

If there is no empty pattern, delete an unneeded pattern first (→ p. 33).

2. Press the [FUNCTION] key and then pad 5 (QUANTIZE).

The current quantize setting appears on the display. The minimum unit (shortest note) for step recording is determined by this setting.

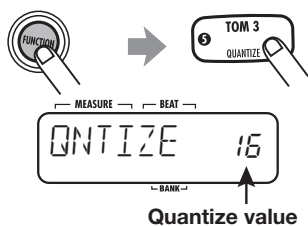

3. Use the VALUE [+]/[-] keys to select the quantize value (step length) from the following values.



4..... Quarter note	24..... Sixteenth triplet note
8..... Eighth note	32..... Thirty-second note
12.... Eighth triplet note	48..... Thirty-second triplet note
16.... Sixteenth note	Hi 1 tick (1/96 of quarter note)

4. Press the [FUNCTION] key once more.

The quantize value is set, and the unit returns to pattern mode.

5. Press the REC [●] key.

The REC [●] key lights up and pattern step input becomes possible.



6. To enter a note, press the pad corresponding to the sound, and then press the [REPEAT/STEP] key.



The note is entered, and the input position advances by one step.

HINT

You can check the current position in the pattern on the display (measure/beat/tick).

7. To enter a rest, press the [REPEAT/STEP] key only.



If you press the [REPEAT/STEP] key without pressing a pad, no note is entered, and the input

position advances by one step.
When the end of the pattern is reached, the recording loops back to the beginning and continues, allowing you to add to the recording.

- To erase the sound of a specific pad, use the [REPEAT/STEP] key to move to its position. Then press the corresponding pad while holding down the [DELETE/ERASE] key.**

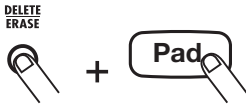

When you move the position with the [REPEAT/STEP] key, the pad for the sound input at the current point lights up. When you delete the sound by pressing the pad while holding down the [DELETE/ERASE] key, the pad goes out.

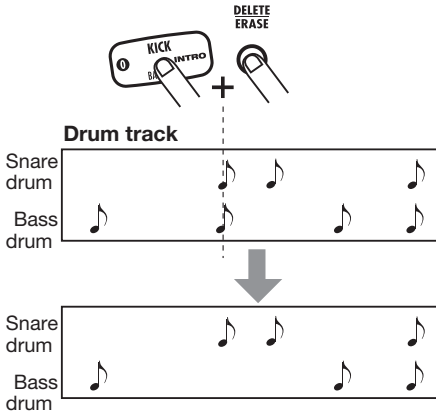

NOTE

During step input, it is not possible to erase the entire track in one go.

- When step input of the drum track is finished, press the STOP [■] key.**



The REC [●] key goes out, and step input terminates.

Step recording of bass track

Now let's add a bass track to the drum track recorded as described in the previous section. Because pitch and duration must be specified for the bass track, the procedure is slightly different from step recording of the drum track.

- In pattern mode, press the [BASS] key.**



The bass track is selected. The bass program selection method is the same as for real-time recording (→ p. 25).

- Press the [FUNCTION] key and then pad 5 (QUANTIZE).**

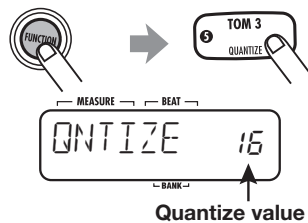

You can now set the quantize value.

3. Use the VALUE [+]/[-] keys to select the quantize value (step length).

For information on quantize values, see page 23.

4. Press the [FUNCTION] key once more.

The quantize value is set, and the unit returns to pattern mode.

5. Press the REC [●] key.

The display changes as follows, and step input becomes possible.

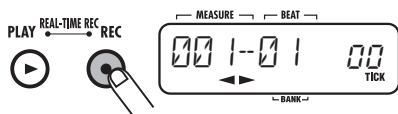

6. Press the left or right cursor key.

The display changes as follows. Here you can set the duration value.



The following settings for note duration are available.

- 1 - 8 Quarter note x 1 - 8
- 3/2 Dotted quarter note
- 3/4 Dotted eighth note
- 1/2 Eighth note
- 1/3 Eighth triplet note
- 1/4 Sixteenth note
- 1/6 Sixteenth triplet note
- 1/8 Thirty-second note

7. Use the cursor keys to select the duration value.



After a while, the screen of step 5 appears again.

8. To enter a note, press the pad for the pitch, and then press the [REPEAT/STEP] key.



The note is entered, and the input position advances by one step. The sound duration will be as specified earlier. You can check the current position in the pattern on the display (measure/beat/tick).

NOTE

If the entered duration exceeds the pattern length, the note will continue until the end of the pattern.

9. To advance to the next step, press the [REPEAT/STEP] key.



If you press the [REPEAT/STEP] key without pressing a pad, the position advances by one step without note entry.

- 10. To erase a note, use the [REPEAT/STEP] key to move to its position. Then press the corresponding pad while holding down the [DELETE/ERASE] key.**

As you move the position with the [REPEAT/STEP] key, the pad that has been input for the current position lights up. Pressing the pad while holding the [DELETE/ERASE] key down causes the pad to go out and the note will be erased.

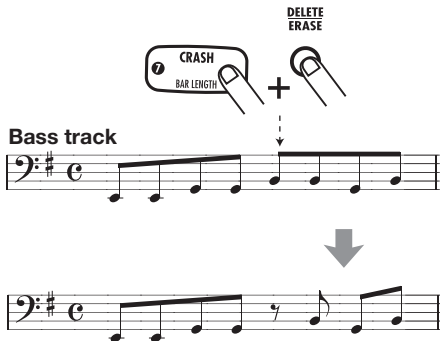

HINT

If necessary, specify a root for the pattern that suits the entered bass phrase. The BASS KEY setting (p. 64) is used to set the root information for the pattern. For patterns that are not to be used in a song or for patterns where the bass track is empty, making the setting is not required.

- 11. Repeat steps 8 - 10 while changing the quantize value and duration setting, to proceed until the end of the pattern.**

When the end of the pattern is reached, the unit automatically loops back to the first measure.

- 12. When step input of the bass track is completed, press the STOP [■] key.**



The REC [●] key goes out, and step input is completed.

Editing a Pattern

This section explains how to edit patterns.

Copying a pattern/ Returning a pattern to the factory default condition

You can copy the currently selected pattern to another position. This is useful to change only a part of a pattern, such as changing the bass track phrasing while keeping the drum track. Patterns that were preprogrammed at the factory (patterns 0 - 439) can be returned to their original condition by the copy process described below.

NOTE

When the copy is executed, the existing contents of the pattern selected as copy target will be erased. Use this function with care.

1. Press the [PATTERN] key.



The RT-223 goes into pattern mode, and the pattern selection screen appears.

2. Use the VALUE [+]/[-] keys to select the pattern to use as copy source.



3. Press the [INSERT/COPY] key.



The [INSERT/COPY] key flashes and the current pattern is selected as the copy source.

4. Use the VALUE [+]/[-] keys to select the pattern to be used as copy target.



HINT

When you select an empty pattern, the indication "E" appears to the right of the pattern number.

To return one of the factory preprogrammed patterns (0 - 439) to the original condition, select the same number as copy source and copy target (the indication "COPY" appears on the display). Then proceed to step 5.

5. To execute the copy, press the [INSERT/COPY] key.

• When you have selected an empty pattern as copy target

The copy is carried out when you press the [INSERT/COPY] key.

• When you have selected an existing pattern as copy target

The indication "REPLACE" appears on the display when you press the [INSERT/COPY] key. To execute the copy, press the [INSERT/COPY] key once more.

• When you have selected the same pattern as copy source and copy target

The indications "FACTORY" and "REVERT" appear alternately on the display when you press the [INSERT/COPY] key. To execute the

factory restore process, press the [INSERT/COPY] key once more.

When the copy or factory restore process is completed, the indication “DONE” appears on the display, and the unit returns to the pattern mode. By pressing the [EXIT] key instead of the [INSERT/COPY] key, you can cancel the process and return to pattern mode.

Erasing a pattern

A user pattern can be erased when it is no longer needed. This can be useful to free up memory space.

NOTE

When a pattern has been erased, its contents can no longer be restored. Use this function with care.

1. In pattern mode, select the pattern to be erased.

2. Press the [DELETE/ERASE] key.



The [DELETE/ERASE] key flashes, and the current pattern name and number alternate with the indication “DELETE” on the display.

3. To execute the erasing process, press the [DELETE/ERASE] key once more.

To cancel the process, press the [EXIT] key instead of the [DELETE/ERASE] key.

Assigning a name to a pattern

When you have selected an empty pattern and created a new pattern, the name “PAT xxx” (where xxx is the pattern number) will automatically be assigned to it. You can change this name later.

1. In pattern mode, select the pattern whose name you want to change.

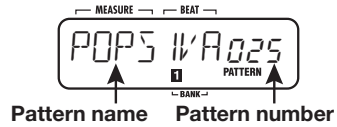

2. Press the [EDIT] key.

The currently selected character of the pattern name flashes.

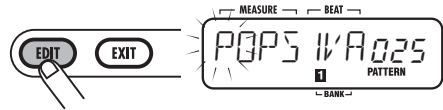

3. Use the cursor left/right keys to move the cursor position, and use the VALUE [+]/[-] keys to select the character.

The following characters are available.

Numbers: 0 - 9

Letters: A - Z

Symbols: (space), () * + - /

4. Repeat step 3 until the name is complete.

5. When name input is completed, press the [EXIT] key.

The name is accepted, and the RT-223 returns to the pattern mode.

Creating Songs (Song Mode)

This section explains what a song in the RT-223 is and how to create songs.

What is a song?

A song in terms of the RT-223 is a sequence of patterns (a number of measures of drum track and bass track) lined up in play order, to provide the backing for an entire musical piece (see illustration below). The maximum number of songs that can be stored in the RT-223 is 100.

A song can be input in three different ways.

• Step input

With this method, you start at the beginning of the song and proceed in discrete steps, specifying the pattern to play and the number of measures for each step. This method is suitable for detailed, manual work on a song.

• Real-time input

With this method, you first assign the patterns to the pads and then play the patterns in real time. This method is suitable for quick and intuitive input of a song.

• FAST (Formula Assisted Song Translator)

This method uses simple formulas to specify rhythm pattern playback from start to end. The result is written out as a song in a single operation. This method is suitable for songs with repeated patterns and cases where the configuration of the entire song has been decided beforehand.

HINT

- The resulting song is the same, regardless of

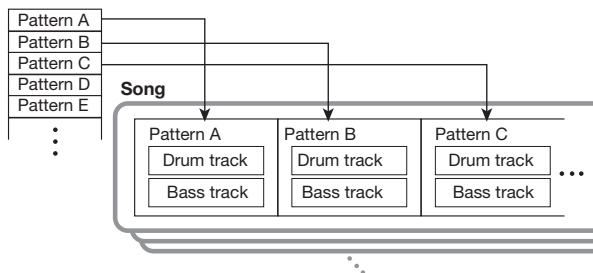

which input method was used. After creating a song with FAST input or real-time input, you can still fine-tune it with step input.

- Besides pattern information, a song also contains so-called event data (tempo, beat, volume and other information, see page 42). Use step input to enter event information.

Creating a song using step input

This section explains how to create a song by lining up patterns one by one.

1. Press the [SONG] key.

The [SONG] key lights up and the RT-223 goes into song mode. The name and number of the currently selected song are shown on the display.

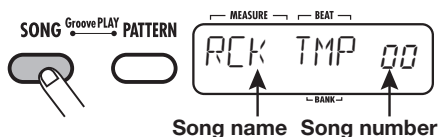

2. Use the VALUE [+]/[-] keys to select a song for which "EMPTY" is shown.

HINT

- If there is no empty song, you may have to erase a song that is no longer needed (→ p. 47).

- Keeping a VALUE [+]/[-] key depressed changes numbers continuously.
- To change numbers quickly, hold down one of the VALUE [+]/[-] keys and press the other key. The numbers will change rapidly.

3. Press the REC [●] key.

The REC [●] key lights up and the display changes as follows. This screen is used for step input.

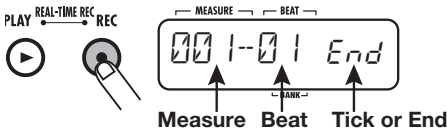

The “End” indication means that the song is currently at the end position. For an empty song where no information has been input, the start and “End” point are identical.

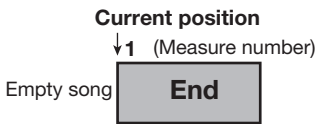

4. Press the [INSERT/COPY] key.

The display changes as follows, and pattern input becomes possible.

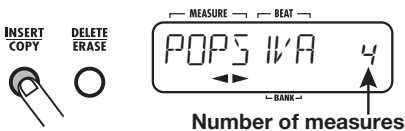

5. Use the VALUE [+]/[-] keys to select the pattern to input.

The selected pattern name appears on the display.

6. Use the cursor left/right keys to set the number of measures for the pattern.

If the selected number is higher than the original number of measures for the pattern, the same

pattern will be repeated. If a smaller number is selected, the sound will switch to the next pattern partway through.

7. When the setting is complete, press the [INSERT/COPY] key.

The pattern with the specified number of measures is inserted, and the display shows the new end position of the song. This means that the “End” indication has now moved to the last measure.

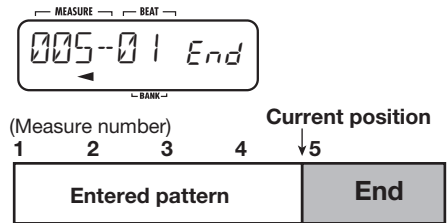

During step input of a song, the input position can be moved by the following actions.

- **Jumping to event positions**
Use the VALUE [+]/[-] keys. With each push of a key, the input position moves to the next or previous event point.
- **Moving in measure units**
Use the cursor left/right keys. With each push of a key, the input position moves to the next or previous measure.
- **Moving in sixteenth note units**
Use the [REPEAT/STEP] key. With each push of the key, the input position moves in sixteenth note units.

8. Repeat steps 4 - 7 to enter all required pattern information.

To edit an entered pattern, you can perform one of the following actions.

- **To reselect a pattern**
Use the cursor left/right keys to move to the point where the respective pattern information is input, and press the [EDIT] key. The event editing screen appears. Now use the cursor left/right keys

to select “PTN”, and use the VALUE [+]/[-] keys to select a new pattern number. To return to the step input screen, press the [EXIT] key. For details on event input/editing, see page 42.

When the pattern is switched within a measure, the new pattern will normally start playing at this point from the beginning. However, you can also have the new pattern start playing from a point other than the beginning. This lets you do things such as inserting the fill-in portion of the new pattern at the third beat of a measure.

To do this, press the [REPEAT] key when the new pattern number is displayed, so that a dot (.) appears next to the pattern number.



Pressing the [REPEAT] key once more turns the dot off. The pattern will be playing from the start.

• **To insert a new pattern in a song**

Move to the point where the pattern is to be inserted and carry out steps 4 - 7. This inserts a pattern at the current position, and shifts all later patterns back by the duration of the inserted pattern.

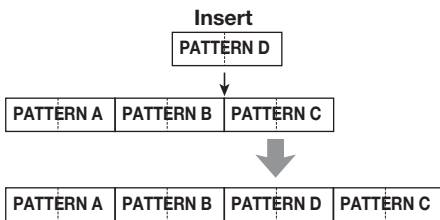

• **To delete a pattern**

Use the cursor left/right keys to move to the pattern to delete, and press the [EDIT] key to switch to the event editing screen. Now use the cursor left/right keys to select “PTN”, and press the [DELETE/ERASE] key. When pattern information is deleted, the “PTN” indication

changes to “←PTN”, which means that the preceding pattern will continue to play. For details on event input/editing, see page 42.

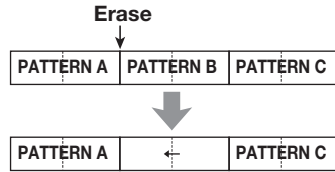

• **To delete a specific measure**

Move to the start of the measure to delete, and press the [DELETE/ERASE] key. The measure is deleted and subsequent events are shifted by one measure forward.

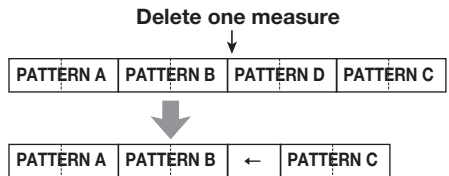

9. To terminate song step input, press the STOP [■] key.



The REC [●] key goes out, and song step input is terminated.

Creating a song using real-time input

In song mode, you can assign different patterns to the 13 pads and play the patterns with the pads. This allows you to play the accompaniment to a performance by hitting the pads to switch patterns. It can also be used to line up patterns for a song in real time, as described below.

HINT

The operation of pads in song mode resembles that of groove play mode (→ p. 48). However, in song mode, it is not possible to play several patterns simultaneously. Switching patterns is only available in measure or beat units.

■ Assigning patterns to pads

This section describes how to assign to the pads the patterns to use in a song.

NOTE

The pattern assignment made in song mode and that made in groove play mode (→ p. 48) are separate. These settings do not influence each other.

1. Press the [SONG] key to activate song mode, and use the VALUE [+]/[-] keys to select a song for which “EMPTY” is shown.

HINT

- In the factory default condition, song numbers 0 - 9 already have patterns assigned to the pads.
- In the factory default condition, song numbers 10 - 99 (for which “EMPTY” is shown) will automatically have the same pattern assignment as used in the previously selected song.

2. Press the [BANK] key.

A screen for making various pad settings appears.



3. Press the pad for which pattern should be assigned.

The pad lights up, and a pattern can be selected.



4. Use the VALUE [+]/[-] keys to select a pattern to assign to the pad.



5. Repeat steps 3 - 4 to assign patterns to the other pads in the same way.

6. When the setting is complete, press the [BANK] key or the [EXIT] key.

The screen of step 1 appears again.

HINT

The pattern information is stored for each song separately.

■ Changing the pattern play method for each pad

You can make changes to the way a pattern plays in song mode, such as transposing the bass track.

1. In song mode, select the song for which to change the settings, and press the [BANK] key.

The screen for making various pad settings appears.



2. Press the pad for which to change the settings.



The pad lights up, showing that it is selected for operation.

3. Use the cursor left/right keys to select a parameter.



The parameters and their setting ranges that are available for each pad are shown in the table below.

Parameter type	Description	Setting range
PATTERN	Number and name assigned to the pad	000 – 511
ROOT	Bass track root	E – D#
NEXT	Operation when switching a pattern	P00 – P12
		F00 – F12
		StP

If the root set for a pattern with BASS KEY (→ p. 64) and the root set for the song are different, the bass phrase is transposed to match the root entered for the song. For example, if the pattern root is set to C for the phrase “G - A - B”, and the song root is set to D, the resulting phrase will be “A - B- C#”.

The NEXT parameter determines the operation when a pad is pressed to switch a pattern and when a pattern has finished playing.

- **P00 - P12**

When the pattern is finished, the pattern of the specified pad (00 - 09: pads 0 - 9, 10: pad [+], 11: pad [x], 12: pad [()]) will be called up.

- **F00 - F12**

The pattern changes at the change of the beat, and when the pattern is finished, the pattern of the specified pad plays.

- **StP**

Playback stops at the end of the pattern.

4. Use the VALUE [+]/[-] keys to change the setting value.

Repeat steps 2 - 4 to make settings for the other pads in the same way.

5. When the setting is complete, press the [BANK] key or the [EXIT] key.

The unit returns to song mode.

■ Using the pads to enter a song in real mode

This section describes how to enter a song in real time by tapping pads to which patterns have been assigned.

1. In song mode, select the song for which to perform real-time input.

HINT

- Song numbers 0 - 9 already have patterns assigned to the pads.
- You can assign patterns to pads yourself. For details, see page 37.

2. Press the PLAY [▶] key while holding down the REC [●] key.



The REC [●] key and PLAY [▶] key light up, and the song is ready for real-time input.

3. Hit the pad to which the first pattern is assigned.

As soon as you hit the pad, real-time recording starts, and the pattern plays. The current measure and beat and the current song number are shown on the display.

Creating Songs (Song Mode)

The basic rules for creating a rhythm pattern sequence are as follows.

• Line up patterns

Use the “+” symbol to line up rhythm patterns. For example, entering 0 + 1 + 2 will result in the following rhythm pattern play sequence.



• Repeat patterns

Use the “x” (multiplication) symbol to specify pattern repetitions. As in normal arithmetic, “x” takes precedence over “+”. For example, entering 0 + 1 x 2 + 2 will result in the following rhythm pattern play sequence.



• Repeat multiple patterns

Use the “(“ and “)” symbols (opening and closing brackets) to link a group of patterns for repetition. Formulas enclosed in brackets take precedence over other formulas. For example, entering 0 + (1 + 2) x 2 + 3 will result in the following rhythm pattern play sequence.

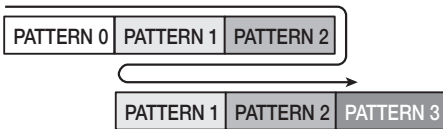

An example for creating the rhythm pattern sequence 0 + (1 + 2) x 3 is shown below.

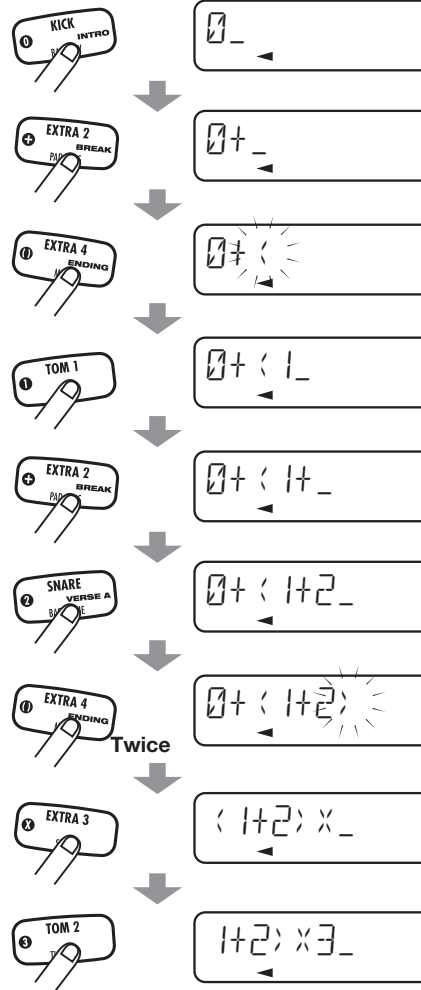

HINT

If the formula exceeds seven digits, earlier character/symbol entries are scrolled off the display. To see the scrolled part, use the cursor left/right keys to move the display position.

NOTE

- The FAST method can only be used to write a song in one go, from beginning to end. Entering patterns partly into the song is not possible.
- To edit a song that was written with this method, edit the formula and then write the entire song again, or use step input.

1. Press the [SONG] key to activate song mode, and use the VALUE [+]/[-] keys to select a song for which "EMPTY" is shown.

NOTE

If you select an existing song and write it out using FAST input, the entire previous content of the song will be overwritten. Use this function with care.

2. Press the [FUNCTION] key and then the REC [●] key.



The indication "FAST" appears briefly on the display. Then an underline cursor appears at the first character position. FAST input is now possible.

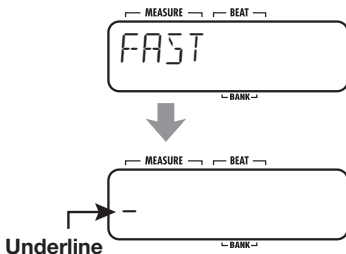

3. Use the pads to enter a formula.

The input method is explained on page 40.



If you make a mistake during input, you can correct it as follows.

• **Deleting a number/symbol**

Use the cursor left/right keys to move the flashing segment to the number/symbol to delete, and press the [DELETE/ERASE] key.

• **Inserting a number/symbol**

Use the cursor left/right keys to move the flashing segment to the point where you want to insert a number or symbol, and input the new number/symbol.

4. When formula input is completed, press the [FUNCTION] key.

The song is written and FAST input terminates.

NOTE

If the entered formula contains a syntax error, the indication "SYTXERR" appears on the display when you press the [FUNCTION] key. After a while, the formula input screen appears again. Correct the wrong part, and perform the write operation again.

Entering event information

Besides pattern information, you can enter various other information (called event data) for a song, such as tempo, beat, and volume. You can gradually fade out the volume or switch the sound of the drum kit or bass program at any point in the song. To add event data to a song for which patterns have already been input, use the step input method.

1. In song mode, select the song for which you want to input an event.

2. Press the REC [●] key.

The REC [●] key lights up, and step input for the song becomes possible.

3. Move to the position where you want to enter event information.

For information on moving the current position, see page 35.

At a point where any kind of event information

including pattern information is input, the "EVENT" indication is shown (see illustration below).



HINT

By using the VALUE [+]/[-] keys during step input of a song, you can move directly to previous or later events.

4. Press the [EDIT] key.

You can now select the event type to enter/edit.

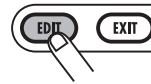

Currently selected event name

Event setting

	"EVENT" indication EVENT	"EVENT" indication EVENT	"EVENT" indication EVENT
Pattern number	000 ←	001 ←	←
Beat	4/4 ←	←	←
Bass track root	E ←	←	←
Tempo	120 ←	←	135
Drum track volume	15 ←	10 ←	←
Bass track volume	15 ←	←	←
Drum kit number	0 ←	2 ←	←
Bass program number	0 ←	←	←

5. Use the cursor left/right keys to select the type of event to enter.



Available event types are shown in the following table.

Event type	Description	Setting range
PTN	Pattern number	000 – 511
TIMSIG	Beat	1 – 8 (1/4 – 8/4)
ROOT	Bass track root	E – D#
TEMPO	Tempo	40 – 250
DR VOL	Drum track volume	0 – 15
BS VOL	Bass track volume	0 – 15
DR KIT	Drum kit	0 – 126
BS PRG	Bass program	0 – 11

If you select an event for which information has already been input at the current position, the event name and setting value are shown on the display. (By pressing the VALUE [+] / [-] keys in this condition, you can change the setting.)

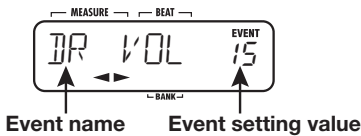

If you select an event for which no information has been input at the current position, the indication "←xxx" (where xxx is the event name) is shown. This means that the preceding information for the same event type remains valid. The following illustration shows an example for the display when the TEMPO event is selected.

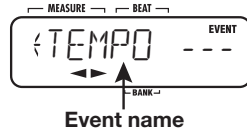

HINT

- If you enter tempo information at the beginning of a song, the song will always play at that tempo, regardless of current tempo settings.
- If the root set for a pattern with BASS KEY (→ p. 64) and the root set for the song are different, the bass phrase is transposed to match the root entered for the song. For example, if the pattern root is set to C for the phrase "G - A - B", and the song root is set to D, the resulting phrase will be "A - B- C#".

6. Use the VALUE [+] / [-] keys to enter the setting value.

When you specify the setting value with the VALUE [+] / [-] keys, the indication "←xxx" (where xxx is the event name) changes to the event name only. This indicates that new event information has been input at the current position.



7. When event information for the current position has been input, press the [EXIT] key to return to the song step input screen.



If required, repeat steps 3 - 7 for other events.

To edit event information that has already been input, proceed as follows.

- **To delete an event**

Call up the event to delete, and press the [DELETE/ERASE] key.

- **To change an event setting value**

Call up the event to edit, and use the VALUE [+]/[-] keys to change the value.

8. To terminate event input, press the STOP [■] key.



The REC [●] key goes out, and song step input is completed.

Playing a song

This section shows how you can select and play a song that you have created.

1. Press the [SONG] key.

The [SONG] key lights up and the RT-223 goes into song mode. The display shows the currently selected song name and number.

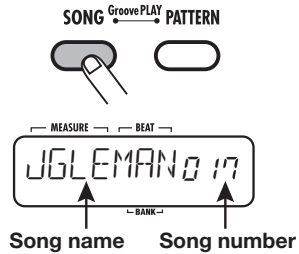

2. Use the VALUE [+]/[-] keys to select the song you want to play, and press the PLAY [▶] key.



The selected song is played back.

3. To stop song playback, press the STOP [■] key.

HINT

While the song is stopped, you can use the cursor left/right keys to move the current position in measure units.

Editing a Song

This section describes how you can edit a song that you have created.

Copying a range of measures

Part of a song specified as a range of measures can be copied to another location. This is useful to have a certain passage play repeatedly.

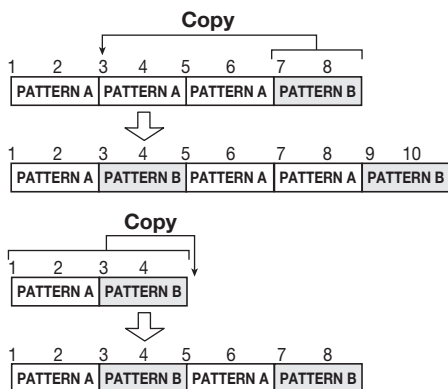

1. Press the [SONG] key.



The RT-223 goes into song mode, and the song selection screen appears.

2. Use the VALUE [+]/[-] keys to select the song to edit.



3. Press the REC [●] key.



The key lights up and song step input becomes possible.

4. Press the [EDIT] key while holding down the [INSERT/COPY] key.

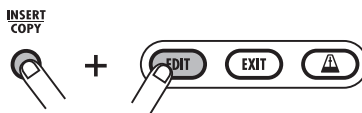

The display changes as follows. On this screen, you can specify the copy start point measure.

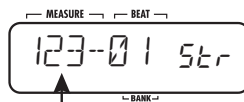

First measure of range to copy

5. Use the VALUE [+]/[-] keys to select the measure to be used as start point of the range to copy. Then press the [INSERT/COPY] key.

The display changes as follows. On this screen, you can specify the copy end point measure.



Last measure of range to copy

6. Use the VALUE [+]/[-] keys to select

the measure to be used as end point of the range to copy. Then press the [INSERT/COPY] key.

The display changes as follows. On this screen, you can specify the insert point for the copied range.



Insert point for range to copy

7. Use the VALUE [+]/[-] keys to select the point where the copied range is to be inserted.

8. To carry out the copy process, press the [INSERT/COPY] key.

The indication "DONE" appears, and the "End" point moves back by the number of copied measures. By pressing the [EXIT] key instead of the [INSERT/COPY] key, you can cancel the process and return to the previous step.

9. To terminate editing, press the STOP [■] key.



Song step input is terminated, and the RT-223 returns to song mode.

Copying a song

The currently selected song can be copied onto another song number. This is useful to create song variations.

NOTE

When you carry out the copy process, any existing song at the copy destination will

be overwritten. Use this function with care.

1. In song mode, select the song to use as copy source.
2. Press the [INSERT/COPY] key.



The [INSERT/COPY] key flashes, and the current song is selected as copy source.

3. Use the VALUE [+]/[-] keys to select the song number of the copy destination.

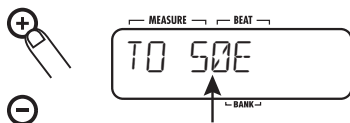

Copy destination song number

HINT

When you select an empty song, the indication "E" appears to the right of the song number.

NOTE

It is not possible to select the current song as copy destination.

4. To carry out the copy, press the [INSERT/COPY] key.

- **If an empty song has been selected as copy destination**
The copy process is carried out when you press the [INSERT/COPY] key.
- **If an existing song has been selected as copy destination**
The indication "REPLACE" appears when you press the [INSERT/COPY] key. To carry out the copy, press the [INSERT/COPY] key once more.

When the copy process is completed, the indication “DONE” appears, and the RT-223 returns to the song mode. If you press the [EXIT] key instead of the [INSERT/COPY] key, the process is canceled and the RT-223 returns to the song mode.

Erasing a song

You can erase the contents of the currently selected song, returning it to the blank state.

NOTE

An erased song cannot be restored. Use this function with care.

1. In song mode, select the song to erase.
2. Press the [DELETE/ERASE] key.



The [DELETE/ERASE] key flashes, and the song name/number indication and the indication “DELETE” are shown alternately on the display.

3. To carry out the erase process, press the [DELETE/ERASE] key once more.

When the erase process is completed, the indication “DONE” appears, and the RT-223 returns to the song mode. If you press the [EXIT] key instead of the [DELETE/ERASE] key, the process is canceled and the RT-223 returns to the song mode.

Assigning a name to a song

When you have selected an empty song and created a new song, the name “SONGxxx” (where xxx is the song number) will automatically be assigned to it. You can change this name later.

1. In song mode, select the song whose name you want to change.

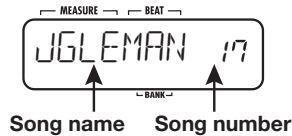

2. Press the [EDIT] key.

The currently selected character of the song name flashes.



3. Use the cursor left/right keys to move the cursor position, and use the VALUE [+]/[-] keys to select the character.

For information on available characters, see page 33.

4. Repeat step 3 until the name is complete.

5. When name input is completed, press the [EXIT] key.



The name is accepted, and the RT-223 returns to the song mode.

Using Pads to Play Patterns (Groove Play Mode)

This section describes the groove play mode. In this mode, the 13 pads are used to play patterns assigned to them. This allows quick switching between patterns during a performance. Up to 4 patterns can be played simultaneously, letting you play two patterns with a different beat, or the same pattern twice, shifted by 1 beat, to create a complex rhythm.

1. Press the [SONG] key and [PATTERN] key simultaneously.



The RT-223 switches to groove play mode. The [SONG] key and [PATTERN] key are both lit. The display shows the name and number of the currently selected song.

NOTE

In groove play mode, all patterns are played with the tempo of the currently selected song. If required, you can enter a desired tempo at the beginning of the song (→ p. 42).

2. Try out the sound by pressing any pad.



In the factory default condition, the RT-223 has 13 patterns specially designed for groove play assigned to the pads. If a pad is held down, the assigned pattern plays repeatedly. The intensity with which the pad is hit controls the overall pattern volume. While the pad is pressed, the pattern name and number are shown on the display.

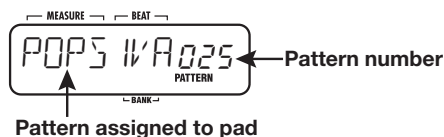

3. To change the pattern assigned to a pad, hold the pad down and use the VALUE [+]/[-] keys to select the new pattern.

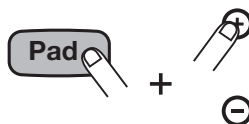

If the VALUE [-] key is pressed while “0” is displayed, or if the VALUE [+] key is pressed while “510” is displayed, the display indication changes to “PAD”. Instead of a pattern, a pad for which “PAD” is selected will play the single sound originally allocated to the pad (such as kick drum or snare).

NOTE

- The pattern assignments made in groove play and those made in song mode (→ p. 37) are separate and independent of each other.
- The patterns assigned to the pads are retained also while the unit is turned off.

4. To repeat a pattern even when the pad is released, hit the pad while holding down the [REPEAT/STEP] key.



The pattern will be looped even when you release the pad. To stop the loop, hit the pad once more. The unit returns to normal groove play.

5. To play several patterns simultaneously, push several pads together.

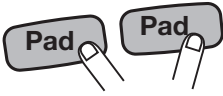

Up to 4 patterns can be played simultaneously, using the same tempo. Slightly shifting the timing when you hit the pads is also possible.

NOTE

If 5 or more pads are pushed, only the patterns of the last 4 pads will be played.

6. To play a song while groove play continues in the background, use the VALUE [+]/[-] keys to select the song number and press the PLAY [▶] key.



In groove play mode, the PLAY [▶] key and STOP [■] key can be used to start or stop the currently selected song. Also while a song is playing, up to four patterns assigned to pads can be played.

HINT

During groove playback, pad operation (press/release) is detected using the quantize value (shortest note) as the detection interval.

This is aimed at matching the timing to other grooves and songs played at the same time. Playing with fast timing is therefore facilitated by choosing a low quantize value. To play with small timing shifts, choose a higher quantize setting.

NOTE

In groove play mode, song editing is not possible.

7. To terminate the groove play mode, press the [SONG] key or [PATTERN] key.

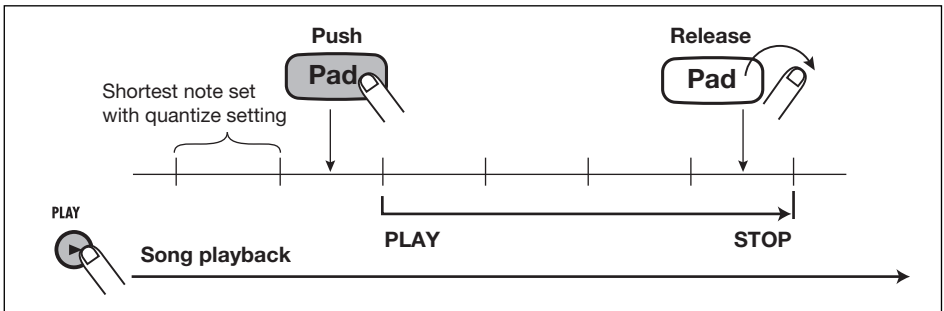
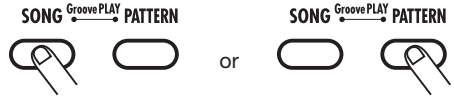

Various Drum Kit Functions (Kit Mode)

The RT-223 incorporates 70 types of drum kits. This section describes how you can create your own drum kit or edit an existing kit.

Creating an original drum kit

To create your very own drum kit, you select drum and percussion sounds and assign them to the pads (13 pads x 3 banks), along with other settings such as panning.

1. Press the [PATTERN] key.

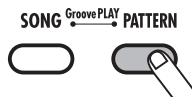

The [PATTERN] key lights up, and the RT-223 goes into pattern mode.

2. Press the [DRUM] key and then the [KIT/PROG] key.

The screen for selecting a drum kit appears.

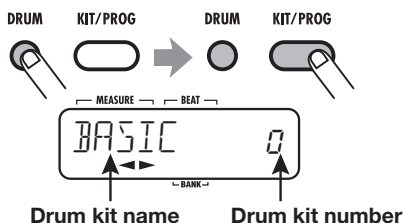

3. Use the VALUE [+]/[-] keys to select a drum kit, and then press the [EDIT] key.

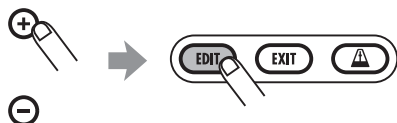

A menu for making individual pad settings appears.

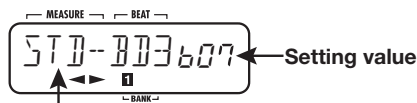

Selected item (in this example: sound name)

4. Use the [BANK] key and the 13 pads to select a pad.

The selected pad lights up, and the setting can be made.

5. Use the cursor left/right keys to select one of the following items.



• Sound name

From the single drum and percussion sounds stored in the RT-223, select the sound to assign to the pad. Each sound is identified by a number. For a list of available sounds, see the appendix at the end of this manual.

• PITCH

This lets you fine-tune the pitch of the drum sound assigned to each pad. The setting range is -7.9 - 0 (reference pitch) - +7.9. The setting can be made in increments of 0.1 (1/10 semitone).

• INSTLVL (Instrument level)

Sets the volume for each pad in the range from 0 to 15.

• PAN (Panning)

Sets the left/right position of each pad when stereo playback is carried out. The setting range is L63 (fully left) - 0 (center) - R63 (fully right).

• **VGROUP (Voice group)**

This setting determines the type of action when the same pad is hit in succession (PL/MN), and the group to which the pad belongs (0 - 7). The setting range is PL0 - PL7 and MN0 - MN7.

If you select PL for a pad, the previous sound of the pad will keep playing in addition to the new sound when you hit the pad in succession. If you select MN for a pad, the previous sound of the pad will stop, and only the new sound is heard when you hit the pad in succession.

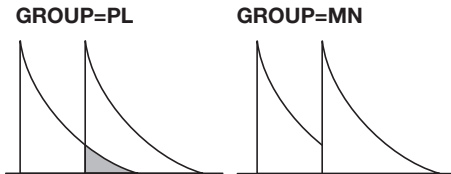

The numeric settings 0 - 7 determine the group of a pad (0: no group, 1 - 7: group 1 - 7). The sounds of pads that are in the same group will not be produced together. By assigning the pads for open hi-hat and closed hi-hat to the same group, the open hi-hat sound will be suppressed when you activate the closed hi-hat sound, resulting in a natural effect.

The group number 0 - 7 applies both to PL and MN. Therefore pads PL1 and MN1 will not produce sound together.

• **SENDLVL (Send level)**

Sets the signal level to be supplied to the REVERB effect. The setting range is 0 - 100.

This setting is made separately for each pad and is independent of the overall drum kit send level setting (→ p. 56) made in effect mode.

To control effect intensity for each pad individually, it may be best to set the effect mode send level to 0 and adjust the SENDLVL parameter for the pads.

NOTE

If the KICKDRY parameter in the patch currently selected for the REVERB effect is ON, changing the send level of a pad to

which the kick drum sound is assigned (pad 0 of pad bank 1/2) has no effect. To turn the KICKDRY parameter on and off, follow the steps described in the section "Editing effect patches".

• **KITNAME (Drum kit name)**

Lets you change the name of the drum kit (→ p. 53).

6. Use the VALUE [+]/[-] keys to adjust the value.



7. Repeat steps 4 - 6 for the other pads.

8. When the setting is complete, press the [EXIT] key.



The settings are automatically saved, and the drum kit select screen appears again. To return to pattern mode, press the [PATTERN] key.

Copying a drum kit/ Returning a drum kit to the factory default condition

You can copy the currently selected drum kit to another position. This is useful to copy an existing preprogrammed drum kit and then change only a part of it to quickly create your original.

By specifying the same drum kit as copy source and copy target, you can return the drum kit to its factory default condition.

NOTE

When the copy is executed, the existing contents of the drum kit selected as copy target will be erased. Use this function with care.

1. Press the [PATTERN] key.

The [PATTERN] key lights up and the RT-223 goes into pattern mode.

2. Press the [DRUM] key and then the [KIT/PROG] key.

The screen for selecting a drum kit appears.

3. Use the VALUE [+]/[-] keys to select the drum kit to be used as copy source.

4. Press the [INSERT/COPY] key.



The [INSERT/COPY] key flashes, and the current drum kit is selected as copy source.

5. Use the VALUE [+]/[-] keys to select the number of the copy destination drum kit.



To return a drum kit to the factory default condition, select the same number as copy source and copy target (the indication “COPY” appears on the display). Then proceed to step 6.

6. To execute the copy, press the [INSERT/COPY] key.

- If a different drum kit number is selected for the copy source and copy target

The copy will be carried out when you press the [INSERT/COPY] key.

- When you have selected the same drum kit as copy source and copy target

The indications “FACTORY” and “REVERT” appear alternately on the display when you press the [INSERT/COPY] key. To execute the factory restore process, press the [INSERT/COPY] key once more.

When the copy process is completed, the indication “DONE” appears, and the RT-223 returns to the drum kit select screen. If you press the [EXIT] key instead of the [INSERT/COPY] key, the process is canceled and the RT-223 returns to the drum kit select screen.

Assigning a name to a drum kit

To give a name to a drum kit or change an existing name, proceed as follows.

1. Press the [PATTERN] key.

The [PATTERN] key lights up and the RT-223 goes into pattern mode.

2. Press the [DRUM] key and then the [KIT/PROG] key.

The screen for selecting a drum kit appears.



3. Use the VALUE [+] / [-] keys to select the drum kit whose name you want to edit.

A menu for making individual pad settings appears.

4. Use the cursor left/right keys to bring up the indication "KITNAME" on the display.

After a while, the current drum kit name appears. The currently selected character of the drum kit name flashes.



HINT

The "KITNAME" parameter applies to all pads.

5. Use the cursor left/right keys to move the cursor position, and use the VALUE [+] / [-] keys to select the character.

For information on available characters, see page 33.

6. Repeat step 5 until the name is complete.

7. When name input is completed, press the [EXIT] key.

The new name is accepted, and the drum kit select screen appears again.

To return to pattern mode, press the [PATTERN] key.

Using Effects (Effect Mode)

This section explains the effects that can be used with the drum kit/bass program.

About the effects

The RT-223 incorporates two types of effects. The COMP EQ effect allows you to directly shape the overall sound of the drum kit/bass program. The REVERB effect is mixed to the original sound of the drum kit/bass program. These two types of effect can be used simultaneously and can be switched individually on and off. The characteristics of each effect type are described below.

■ COMP EQ effect

The COMP EQ effect is inserted in the drum kit/bass program signal output and comprises functions such as compressor and low-fi sound simulation.

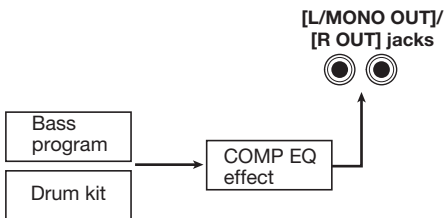

■ REVERB effect

The REVERB effect of the RT-223 lets you adjust effect intensity by controlling the level of the signal sent from the drum kit and bass program to the effect. The signal processed by the REVERB effect is then added to the final stereo signal. For the drum kit, you can also set the send level individually for each instrument sound.

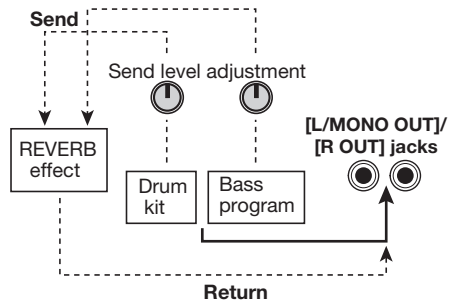

HINT

In effect mode, you adjust the overall send level of the drum kit/bass program. To adjust the send level for individual instruments of the drum kit, perform pad send level adjustment in kit mode (→ p. 51).

About patches

The COMP EQ effect and REVERB effect comprise different effect types that determine the category of the effect and different effect parameters that determine the intensity and other aspects of the effect. By first selecting an effect type and then adjusting its parameters, you can achieve a wide variety of sound characteristics. The sum of these edited effect settings is called a patch. Storing and recalling patches makes it possible to instantly switch among different effect settings. The RT-223 allows you to use 40 patches each for the COMP EQ effect and REVERB effect.

Using the COMP EQ effect

This section describes how to use the COMP EQ effect.

1. In pattern, song, or groove play mode, press the [COMP EQ] key several times, so that the key lights up.

The RT-223 switches to effect mode, and the COMP EQ effect becomes ON. The display changes as follows.

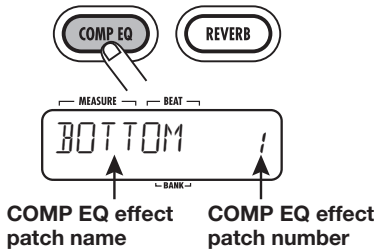

2. Use the VALUE [+]/[-] keys to select the patch to use.



The new patch is called up immediately.

HINT

- When you select an empty patch, the indication “EMPTY” appears on the display. In this case, the sound does not change.
- If a playable pattern or song is selected in pattern or song mode, pressing the PLAY [▶] key will start playback of the pattern or song. This lets you check the sound.

3. To temporarily bypass the COMP EQ effect, press the [COMP EQ] key so that the key goes out.

The COMP EQ effect is turned off, and the indication “BYPASS” is shown on the display. To turn the COMP EQ effect back on, press the [COMP EQ] key once more.

4. When the COMP EQ effect patch has been selected, press the [EXIT] key.



The effect mode is terminated, and the RT-223 returns to the previous mode.

Using the REVERB effect

This section describes how to use the REVERB effect. For this effect, you first select the patch and then separately adjust the send level for the drum kit and bass program.

1. In pattern, song, or groove play mode, press the [REVERB] key several times, so that the key lights up.

The RT-223 switches to effect mode, and the REVERB effect becomes ON. The display changes as follows.

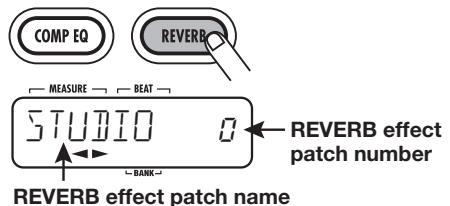

2. Use the VALUE [+]/[-] keys to select

the patch to use.

The new patch is called up immediately.

HINT

When you select an empty patch, the indication "EMPTY" appears on the display. In this case, the sound does not change.

3. Press the [EDIT] key.

The [REVERB] key flashes and the patch edit screen appears.



4. Use the cursor left/right keys to bring up the indication "DR SEND" on the display.

This screen lets you adjust the overall send level of the drum kit.

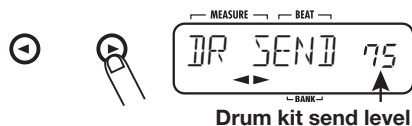

HINT

You can change the send level for each drum/percussion sound separately. To do this, adjust the send level for each pad in kit mode (→ p. 51).

5. Use the VALUE [+]/[-] keys to adjust the drum kit send level. The send level can be adjusted in the range from 0 - 100.

HINT

The REVERB effect comprises the KICKDRY parameter that excludes the sound of the kick drum from effect

processing. When this parameter is ON, the sound of pad 0 in pad bank 1/2 will not be changed by the REVERB effect. (The same applies if the pad send level is raised in kit mode.) For information on how to turn the KICKDRY parameter on and off, see the section "Editing effect patches".

6. Use the VALUE [+]/[-] keys to bring up the indication "BS SEND" on the display.

This screen lets you adjust the send level of the bass program.

7. Use the VALUE [+]/[-] keys to adjust the bass program send level.

8. When the send level patch has been adjusted, press the [EXIT] key.

The RT-223 returns to the condition of step 1.

9. Save the current patch.

For information on how to save an effect patch, see page 58.

NOTE

The send level setting for the drum kit/bass program is saved as part of the patch. If you switch to another patch without storing the edited patch first, the edit contents will be lost.

10. To temporarily bypass the REVERB effect, press the [REVERB] key so that the key goes out.

The REVERB effect is turned off, and the indication "BYPASS" is shown on the display. To turn the REVERB effect back on, press the [REVERB] key once more so that the key is lit.

11. To terminate the REVERB effect setting, press the [EXIT] key.

The effect mode is terminated, and the RT-223 returns to the previous mode.

Editing effect patches

To edit an effect patch, you first select an effect type and then adjust its parameters to fine tune the resulting sound. Since the various effect types have their own effect parameters, switching the effect type will also change the parameters. An example for effect parameters for effect types of the COMP EQ effect is shown below.

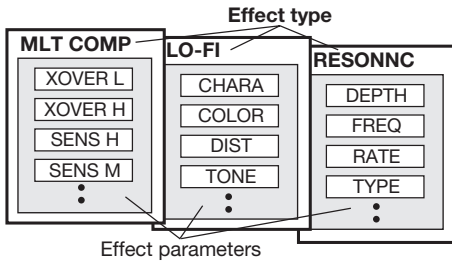

This section explains how to edit the effect patches for the COMP EQ effect and REVERB effect.

1. Press the [COMP EQ] key (to edit the COMP EQ effect) or the [REVERB] key (to edit the REVERB effect) several times, so that the key lights up.

The RT-223 switches to effect mode, and the patch select screen appears.

2. Use the VALUE [+]/[-] keys to select the patch to edit.

HINT

To change the effect intensity of the REVERB effect, use the cursor left/right keys to bring up the indication "DR SEND" on the display, and adjust the send level.

3. Press the [EDIT] key.

The [COMP EQ] key or [REVERB] key flashes,

and the patch edit screen appears.



HINT

When "EFFECT" is shown on the display, you can use the VALUE [+]/[-] keys to switch the effect on and off.

4. Press the cursor right key once to bring up the effect type indication on the display.

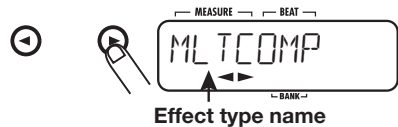

5. Use the VALUE [+]/[-] keys to select the effect type to use.

HINT

If a playable pattern or song is selected in pattern or song mode, pressing the PLAY [▶] key will start playback of the pattern or song. This lets you check the sound.

6. Use the cursor left/right keys to select the effect parameter to edit.

Which effect parameters are displayed will depend on the effect type.

In the illustration below, MLTCOMP has been selected as effect type of the COMP EQ effect, and the "XOVER H" parameter is displayed.

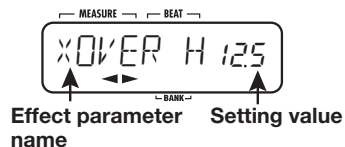

7. Use the VALUE [+]/[-] keys to change the setting value.

For information on effect types and effect parameters, see the appendix at the end of this manual.

8. Repeat steps 6 - 7 as necessary to adjust other effect parameters.

HINT

- When editing the COMP EQ effect, you can bring up "LEVEL" to adjust the overall volume level of the patch.
- When editing the REVERB effect, you can bring up "EFX LVL" to adjust the mixing amount of the effect sound.
- When editing the REVERB effect, you can bring up "KICKDRY" to individually switch the effect off and on for pad 0 of pad bank 1/2 (usually assigned to the kick drum).

9. When you have finished editing the patch, press the [EXIT] key.

The patch select screen appears again. Press the [EXIT] key once more to terminate effect mode.

NOTE

If you switch to another patch without storing the edited patch first, the edit contents will be lost. For information on how to store a patch, see the next section.

Storing, swapping, or initializing effect patches

This section explains how to store a patch of the COMP EQ effect or REVERB effect.

If you store an already stored patch in another location, a copy of the patch is created. You can also swap two patches in their respective locations, or use this procedure to restore a patch to the factory default condition.

1. At the patch select screen for the COMP EQ effect or REVERB effect, select the patch to store or swap.

HINT

- You can also store or swap patches from the patch editing screen. In this case, the patch being edited will be the one that is stored or swapped.
- To initialize a patch, select the patch that you want to return to the factory default condition.

2. Press the [INSERT/COPY] key.

The [INSERT/COPY] key flashes, and the patch name/patch number and the indication "STORE >" are shown alternately on the display.



3. Use the cursor left/right keys to select the "STORE >", "SWAP >", or "FACTORY" (initialize) action.

If you have selected "SWAP >", the patch name/patch number and the indication "SWAP >" are shown alternately on the display.



If you have selected "FACTORY", the indications "FACTORY" and "REVERT" are shown alternately on the display. To continue with the initialize procedure, go directly to step 5.

4. If you have selected "STORE >" or "SWAP >", use the VALUE [+]/[-] keys to select the store/swap target patch number.



When store was selected, the current patch will be stored in this patch number.
When swap was selected, the current patch will be swapped with the patch in this patch number.

5. To carry out the process, press the [INSERT/COPY] key.

Store, swap, or factory initialize is carried out, and the patch select screen appears again. If you press the [EXIT] key instead of the [INSERT/COPY] key, the respective process is canceled.

Assigning a name to an effect patch

To give a name to a patch of the COMP EQ effect or REVERB effect, proceed as follows.

1. From the COMP EQ effect or REVERB effect patch select screen, select the patch whose name you want to change.

The patch name/patch number are shown.



2. Press the [EDIT] key.



The patch edit screen appears. The display shows

the effect type.

3. Use the cursor left/right keys to bring up the indication "PATNAME" on the display.

After a while, the name of the current patch appears. The currently selected character of the patch name flashes.



4. Use the cursor left/right keys to move the cursor position, and use the VALUE [+]/[-] keys to select the character.

For information on available characters, see page 33.

5. Repeat step 4 until the name is complete.

6. When name input is completed, press the [EXIT] key.

The patch select screen appears again. Press the [EXIT] key once more to terminate effect mode.

NOTE

If you switch to another patch without storing the edited patch first, the edit contents will be lost. For information on how to store a patch, see the previous section.

Using the Metronome (Metronome Mode)

The RT-223 incorporates a metronome function that is ideal to provide a guide rhythm for practice. The metronome also lets you use mixed beat patterns, such as 2 + 3 or 3 + 4 beat combinations.

■ Beat types

The metronome of the RT-223 supports beats using quarter notes or eighth notes as denominator (unit note). The following numerators (number of beats) can be selected.

Denominator (unit note)	Numerator (number of beats)
Quarter note	1, 2, 3, 4, 2+3, 3+2, 3+3, 6, 3+4, 4+3
Eighth note	6/8, 7/8, 12/8

Within the beats using the quarter note denominator, there are five subtypes (C1, C2, C3, C4, C5) that differ in dynamics and count detail. For example, if a 4/4 beat is selected, the C1 - C5 variations are as follows.

● C1

● C2

● C3

● C4

● C5

NOTE

- Depending on the beat type, some dynamics combinations are not available.
- For beats using the eighth note denominator (6/8, 7/8, 12/8), the dynamics cannot be changed.

■ Mixed beat patterns

When using the metronome at a 5/4 beat, you can select 2 + 3 or 3 + 2 as a numerator.

● 2+3 C1

● 3+2 C1

In the same way, when using the metronome at a 7/4 beat, you can select 3 + 4, or 4 + 3, resulting in different ways of counting the measure.

● 3+4 C1

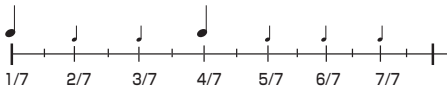

● 4+3 C1



To use the metronome function, proceed as follows.

1. In pattern, song, or groove play mode, press the [METRONOME] key.

The [METRONOME] key lights up, and the RT-223 goes into metronome mode. The display shows the metronome pattern name and pattern number.

The pattern name consists of a numeral/symbol combination that stands for the beat type, and a numeral that stands for the stress dynamics setting. For a list of available beats and dynamics settings, see page 60.

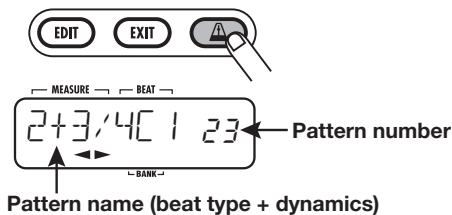

HINT

- When the RT-223 is in metronome mode, all effects are bypassed and no effect processing is carried out.

2. Use the VALUE [+]/[-] keys to select the metronome pattern.



3. To change the sound of the metronome, press the [KIT/PROG] key and use the cursor left/right keys to select the sound.

Available sound choices for the metronome are as follows.

Display	indication and corresponding sound
M-BELL	Metronome sound
M-CLICK	Metronome sound (click only)
STICK	Stick beating sound
COWBELL	Cowbell sound
HIGH-Q	Synthesizer click sound



4. To quit the sound selection screen, press the [EXIT] key.

The display returns to the condition of step 1.

5. To set the tempo, press the [TEMPO] key and then use the VALUE [+]/[-] keys to adjust the tempo.

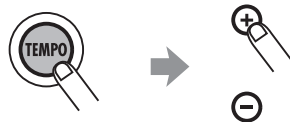

HINT

If you tap the [TEMPO] key twice, the interval is set as a quarter note (tap tempo input function).

- 6. To activate the metronome sound, press the PLAY [▶] key.**



The metronome begins to operate. The display now shows the current beat in real time.



NOTE

When a foot switch is connected to the RT-223 and the foot switch function is not set to “TAP”, the foot switch will automatically be set to control start/stop when the metronome is activated.

HINT

You can change the metronome sound and tempo also while the metronome is operating.

- 7. To stop the metronome, press the STOP [■] key.**



- 8. To terminate metronome mode, press the [PATTERN] key or the [SONG] key.**

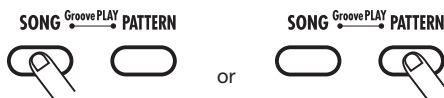

The RT-223 returns to pattern mode or song mode. When metronome mode finishes, the effect bypass condition is canceled and the foot switch setting returns to the original condition.

If you press the [EXIT] key in this step, the RT-223 returns to the previous mode.

Changing Various Settings of the RT-223

The [FUNCTION] key is used to make various settings for the RT-223. The basic steps for using the [FUNCTION] key and the setting items are described below.

Basic function setting procedure

The [FUNCTION] key is used in the same way for most setting items. The basic steps are as follows.

1. Press the [FUNCTION] key.



The [FUNCTION] key flashes, indicating that you can select a setting item.

NOTE

For some items, you must first select the pattern before pressing the [FUNCTION] key, or you must first stop playback. For details, see the description of the respective items.

2. Depending on the desired item, press one of pads 1 - 13 or the [PATTERN] key.

The 13 pads on the top panel and the [PATTERN] key are used to select items. The item is identified by the label below the pad or key, as given in brackets in the following list.

- **Pad 0 (BASS KEY)**
Sets the reference pitch for the bass program as well as the pattern root.
- **Pad 1 (MIX)**
Sets the drum track/bass track level.
- **Pad 2 (BASS TUNE)**
Allows tuning a bass program.
- **Pad 3 (TIME SIG)**
Sets the time signature of the pattern.

- **Pad 4 (PRE COUNT)**
Switches pre-count on or off and sets the number of beats.
- **Pad 5 (QUANTIZE)**
Sets the quantize value.
- **Pad 6 (CLICK VOL)**
Sets the metronome volume.
- **Pad 7 (BAR LENGTH)**
Sets the number of measures for the pattern.
- **Pad 8 (FOOT SW)**
Sets the foot switch function.
- **Pad 9 (SWING)**
Sets the amount of swing for playback.
- **Pad [+] (PAD SENS)**
Adjusts the pad sensitivity.
- **Pad [x] (SHIFT)**
Shifts the playback timing backwards or forwards.
- **Pad [0] (MIDI)**
Sets reception of MIDI synchronization messages on and off and assigns the MIDI channel for each track.
- **[PATTERN] key**
Serves to display remaining memory capacity.

NOTE

For some items, the sound or track that is to be set must be selected after selecting the item.

3. Use the VALUE [+]/[-] keys to change the setting.

HINT

- Keeping a VALUE [+]/[-] key depressed changes numbers continuously.
- To change numbers quickly, hold down one of the VALUE [+]/[-] keys and press the other key. The numbers will change rapidly.
- When you change a function setting, the

new setting becomes effective immediately. To return to the previous setting, perform the setting procedure again.

4. Press the [FUNCTION] key once more, or press the [EXIT] key.

The function setting mode is terminated.

HINT

The [FUNCTION] key is also used for demo song playback (→ p. 8), FAST input (→ p. 39), and other functions.

Function setting items

This section explains the various items that can be set and gives information on the setting range.

■ Setting bass program reference pitch (BASS KEY)

Setting range: C - B

This sets the pitch assigned to pad 0 in the range from C to B. The note set here also expresses the root of the pattern.

When you use the VALUE [+]/[-] keys to change the pitch of pad 0, the pitch of pads 1 - 9, [+], [x], and [O] also is shifted accordingly.

A sharp pitch (#) is expressed as “[□]” (where □ stands for #).

HINT

This setting is stored for each pattern individually.

■ Setting the drum track/bass track level (MIX)

Setting range: 0 - 15

Sets the volume for each track in a pattern over a range of 0 - 15.

After selecting this item, use the [DRUM] or [BASS] key to select the track and then use the VALUE [+]/[-] keys to make the setting.

HINT

This setting is stored for each pattern individually.

■ Tuning a bass program (BASS TUNE)

Setting range: 435 - 445 (Default: 440)

Allows tuning the bass program in the range of A = 435 Hz to A = 445 Hz.

■ Setting the time signature of a pattern (TIME SIG)

Setting range: 1, 2, 3, 4, 5, 6, 7, 8

Set the time signature for the pattern to 1 - 8 (1/4 - 8/4 beat).

The time signature of an already recorded pattern (indicated by “*” on the display) is not possible.

HINT

This setting is stored for each pattern individually.

■ Setting the pre-count (PRE COUNT)

Setting range: OFF, 1 - 8, SP (Default: 4)

The pre-count (number of metronome ticks before the start of pattern real-time recording) can be turned on and off, and the number of measures etc. can be set. This setting applies to all patterns. The settings have the following meaning.

- OFF
Pre-count is off.
- 1 - 8
Real-time recording starts after the respective number of measures has been counted.
- SP
Real-time recording starts after the following special pre-count was heard.



■ Setting the pattern resolution (QUANTIZE)

Setting range: 4, 8, 12, 16, 24, 32, 48, Hi (Default: 16)

Sets the quantize value (shortest note) for the pattern. The quantize setting affects the following four functions:

- Shortest note for real-time recording
- Shortest note for step recording
- Sound interval when [REPEAT/STEP] key is used together with pad for continuous repetition
- Pad push/release detection timing during groove play

The following 8 settings are available for the quantize value.

4Quarter note	24Sixteenth triplet note
8Eighth note	32Thirty-second note
12Eighth triplet note	48Thirty-second triplet note
16Sixteenth note	Hi 1 tick (1/96 quarter note)

NOTE

- Even if Quantize is set to Hi, the continuous repetition interval for the [REPEAT/STEP] key is a thirty-second triplet note.
- If you press the REC [●] key instead of the [FUNCTION] key in step 4 of “Basic function setting procedure”, the note recorded in the currently selected pattern is aligned with the quantize value.

■ Setting the metronome volume level (CLICK VOL)

Setting range: 0 - 15 (Default: 15)

The volume level of the metronome click sound heard during real-time recording can be adjusted with this setting.

The setting applies to all patterns.

■ Setting the number of measures for a pattern (BAR LENGTH)

Setting range: 1 - 99

Sets the length of the pattern in the range from 1 - 99 measures. After setting the pattern length, press the [FUNCTION] key to confirm the setting. The initial setting for an empty pattern is then changed.

Changing the length of an already recorded pattern is also possible. To do this, select the pattern for which you want to make the change, and then press the REC [●] key instead of the [FUNCTION] key in step 4 of “Basic function setting procedure”. The action will change as follows.

- Making the number of measures larger
Blank measures are added to the end of the pattern.
- Making the number of measures smaller
The excess measures at the end of the pattern are cut off.

HINT

This setting is stored for each pattern individually.

■ Selecting the foot switch function (FOOT SW)

Setting range: PAD00 - PAD38, TAP, COUNT, START, MUTE, REPEAT, JAM (Default: JAM)

This setting determines the function of a foot switch (FS01) connected to the [FOOT SW] jack on the rear panel.

The setting is made by pressing the [FUNCTION] key followed by pad 8 (FOOT SW). The indication “FOOT SW” appears on the display, and then the currently selected foot switch function is shown. In this condition, you can change the setting.

Available settings and setup procedures are listed below.

- Playing a drum sound of a pad with FS01
You can play one of the drum sounds assigned to the pads of a pattern with the foot switch. This is useful to play the bass drum with your

foot. To make the setting, press the [FUNCTION] key followed by pad 8 (FOOT SW), and then press the desired pad from the 13 pads x 3 banks. (The strength with which you hit the pad is also recorded.) Depending on the selected pad, the indication PAD00 - PAD38 is shown.

- **Switching pad drum sounds with FS01**

You can switch between two drum sounds assigned to the pads of a pattern with the foot switch. To make the setting, press the [FUNCTION] key followed by pad 8 (FOOT SW). Then push the FS01 down and press the first pad. Release the FS01 and press the second pad. The sound of the first pad can now be switched with the FS01. When the foot switch is pushed down, the sound of the first pad is heard. When it is released, the sound of the second pad is heard. The left three digits of the display show the number of the first pad, and the right three digits the number of the second pad.

To switch between open hi-hat and closed hi-hat with your foot, push the FS01 and press pad 4 (CLOSED HAT). Then release the FS01 and press pad 6 (OPEN HAT).

- **Using the FS01 to set the tempo**

You can adjust the tempo by tapping the foot switch twice in succession (tap tempo function). To make the setting, press the [FUNCTION] key followed by pad 8 (FOOT SW), and then press the [TEMPO] key. (The indication "TAP" appears on the display.)

- **Using the FS01 to control start/pause**

With this setting, the FS01 will function in the same way as the PLAY [▶] key, switching between "Start play" → "Pause" → "Resume play" with every push. To make the setting, press the [FUNCTION] key followed by pad 8 (FOOT SW), and then press the PLAY [▶] key. (The indication "COUNT" appears on the display.)

- **Using the FS01 to control start/stop**

With this setting, the FS01 will function in the same way as when the PLAY [▶] key and STOP [■] key are pressed alternately, switching between "Start play" → "Stop" →

"Start play from beginning" with every push. To make the setting, press the [FUNCTION] key followed by pad 8 (FOOT SW), and then press the STOP [■] key. (The indication "START" appears on the display.)

- **Using the FS01 to mute a desired track**

With this setting, the currently selected track (drum or bass) is muted when the foot switch is pressed. To make the setting, press the [FUNCTION] key followed by pad 8 (FOOT SW), and then press the VALUE [-] key. (The indication "MUTE" appears on the display.)

- **Using the FS01 to control continuous percussion sound**

With this setting, you can play the sound of a pad continuously by hitting the pad with the foot switch pushed down. To make the setting, press the [FUNCTION] key followed by pad 8 (FOOT SW), and then press the [REPEAT/STEP] key. (The indication "REPEAT" appears on the display.)

- **Using the FS01 to control jam play (song mode only)**

When the RT-223 is in song mode, the FS01 can be used for the jam function that allows switching between multiple patterns simply by pressing the foot switch. To make the setting, press the [FUNCTION] key followed by pad 8 (FOOT SW), and then press the [SONG] key. (The indication "JAM" appears on the display.) For details on the jam function, see page 68.

■ Setting the playback swing amount (SWING)

Setting range: 8th, 16th/50 - 75 (Default: 8th/50)

This setting controls the swing amount (rhythm flourish).

To make the setting, press the [FUNCTION] key followed by pad 9 (SWING). The indication "SWING" is shown on the display for a while. When the display indication changes, use the cursor left/right keys to select "8th" (swing in eighth note units) or "16th" (swing in sixteenth note units), and then use the VALUE [+]/[-] keys change the setting value. With a setting of 50, there is no change. Higher values result in more

swing. (The values stand for percent.) This item influences only the playback timing. It does not affect the recorded data of the pattern.

■ Setting the pad sensitivity (PAD SENS)

Setting range: SOFT, MEDIUM, LOUD, LIGHT, NORMAL, HARD, EX HARD
(Default: NORMAL)

This setting controls the pad sensitivity. The following seven settings are available.

- **SOFT**
Low volume regardless of pad hitting intensity
- **MEDIUM**
Medium volume regardless of pad hitting intensity
- **LOUD**
High volume regardless of pad hitting intensity
- **LIGHT**
Highest sensitivity setting. Results in loud volume even when pad is hit only lightly.
- **NORMAL**
Medium sensitivity setting
- **HARD**
Low sensitivity setting. Pads must be hit hard to produce volume.
- **EX HARD**
Lowest sensitivity setting. Pads must be hit extra hard to produce volume.

■ Setting the playback timing shift (SHIFT)

Setting range: -192 to +192 (Default: 0)

Shifts the playback timing of a specific track in the currently selected pattern back or forth in 1-tick units (1/96 of a quarter note). The maximum shift is ± 2 beats.

NOTE

- Once the setting is made, it cannot be undone. Use this function with care.
- When you shift the playback timing of a track, the preceding or following notes are deleted.

■ Setting MIDI synchronization message input on/off (MIDI) Setting range: int, Ext (Default: int)

When this item is set to “Ext”, the RT-223 accepts the following MIDI messages:

- **MIDI clock**
- **Start/Stop/Continue**
- **Song Select**

NOTE

When this item is set to “Ext”, real-time input is not possible.

■ Setting the MIDI receive channel for each track (MIDI)

Setting range: oFF, 1 - 16, AUt (bass track only) (Default: drum track = 10, bass track = 9)

This item sets the MIDI channel for each track. Available settings for the drum track are oFF (not received) and 1 - 16. Available settings for the bass track are oFF (not received), 1 - 16, and AUt. “AUt” is a special setting for playing GM compatible standard MIDI files. When the RT-223 receives a program change message for GM bass sound, it automatically switches the bass track to that MIDI channel.

When the [FUNCTION] key is pressed followed by pad [()] (MIDI), the display for setting the drum track/bass track MIDI receive channel to on or off is shown. Hold down the [DRUM] key or [BASS] key (current setting for the track is shown on the display), and use the VALUE [+]/[-] keys to change the setting.

■ Displaying the remaining amount of memory (PATTERN)

Pressing the [FUNCTION] key followed by the [PATTERN] key brings up a percentage display of the remaining amount of memory. This display is for information only, it cannot be changed.

Other Functions

This section describes examples for combining the RT-223 with optional equipment and external components.

Using the jam function

The jam function lets you use the foot switch to play multiple patterns assigned to pads in song mode. This is convenient when you want to use your hands for playing an instrument, while still being able to start patterns and switch them at any desired point.

NOTE

The jam function is available only when the RT-223 is in song mode.

The following four pads can be directly controlled with the jam function: pad 0, pad 4, pad 8, and pad [0].

When you press the foot switch while the RT-223 is stopped, the pattern of pad 0 begins playing.

With each subsequent push of the foot switch, patterns are switched between pad 4 and pad 8. If you hold down the foot switch during play, the pattern switches to pad [0] (see illustration 1 below).

By specifying the NEXT parameter (→ p. 38) for the above pads, you can use other pattern combinations or stop play after a specific pattern.

For example, assume that INTRO is assigned to pad 0 and VERSE A to pad 2. When you set the NEXT parameter for pad 0 to “P02”, pressing the foot switch will cause INTRO to play, followed by VERSE A (see illustration 2 below). Similarly, if FILL A is assigned to pad 4 and VERSE B to pad 6, setting the NEXT parameter for pad 4 to “F06” will cause FILL A to play from the next beat after pressing the foot switch, and then play can be switched to VERSE B (see illustration 3 below).

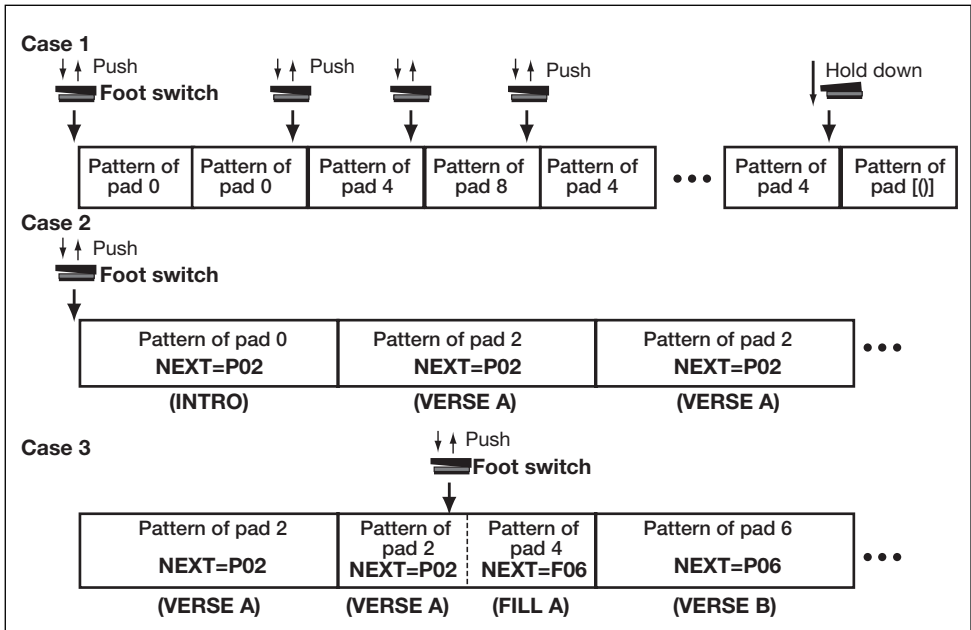

If the ENDING pattern is assigned to pad [0] and the NEXT parameter is set to “StP”, pushing and holding the foot switch will cause the ENDING pattern to be played, and then play will stop.

HINT

For songs which have pre-assigned patterns (song numbers 0 - 9), the NEXT parameter is set as follows for the respective pads.

Pad	NEXT parameter
0	P02
2	P02
4	F06
6	P06
8	F02
[0]	STP

1. Connect the FS01 to the [FOOT SW] jack on the rear panel.
2. Press the [SONG] key to switch the RT-223 to song mode.



3. Press the [FUNCTION] key and then pad 8 (FOOT SW).



The indication “FOOT SW” appears briefly on the display, followed by the currently selected foot switch function.

In this condition, you can change the foot switch function setting.

4. Press the [SONG] key.

The indication “JAM” appears on the display.

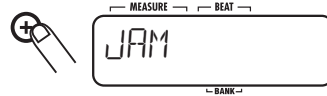

NOTE

When the jam function is assigned to the foot switch, and the RT-223 is in a mode other than song mode, the foot switch will control playback/stop of the pattern/song.

5. Press the [FUNCTION] key.

The foot switch setting is completed. In this condition, you can use the jam function.

6. If required, set the NEXT parameter for each pad (→ p. 38).

7. Push the foot switch.

Playback of the pattern assigned to pad [0] starts. Each subsequent push of the foot switch then switches patterns according to the NEXT parameter setting. If you hold down the foot switch during play, the pattern of pad [0] plays. (If you have set the NEXT parameter of pad [0] to “Stp”, pattern playback will stop after that.)

Synchronizing the RT-223 to external MIDI equipment

The RT-223 can receive MIDI clock signals for synchronized operation with a multi-track recorder, sequencer, rhythm machine, or similar equipment. This allows playback of the patterns or songs of the RT-223 with the tempo determined by the external equipment.

1. Connect the MIDI OUT jack of the MTR, rhythm machine, or other MIDI component to the [MIDI IN] connector of the RT-223, using a MIDI cable.

NOTE

Verify that the external MIDI equipment is capable of sending MIDI Clock and Start/Stop/Continue messages.

2. Press the [FUNCTION] key followed by pad [0] (MIDI).

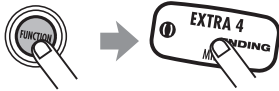

The display for enabling/disabling reception of MIDI sync messages appears.

3. Use the VALUE [+]/[-] keys to bring up the indication “Ext” on the display.

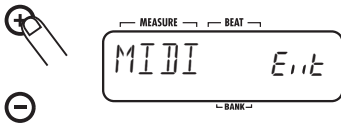

4. Press the [FUNCTION] key.

In this condition, play operation of the RT-223 is synchronized to the external MIDI equipment.

5. Select the pattern or song to play in sync.

6. Start playback at the external MIDI equipment.

The pattern or song of the RT-223 plays in synchronization with the tempo of the external MIDI equipment.

Using MIDI equipment to play the RT-223

Using a MIDI keyboard, MIDI sequencer, or similar MIDI device you can play the built-in

sound sources of the RT-223.

1. Connect the MIDI keyboard, MIDI sequencer, or other MIDI component to the [MIDI IN] connector of the RT-223, using a MIDI cable.

2. Press the [FUNCTION] key followed by pad [0] (MIDI).

The display for enabling/disabling reception of MIDI sync messages appears.

3. Press the [DRUM] key (or [BASS] key).



The current setting value of the selected track appears on the display.

4. While continuing to hold down the key pressed in step 3, use the VALUE [+]/[-] keys to set the MIDI receive channel for the track to the send channel of the external MIDI equipment.

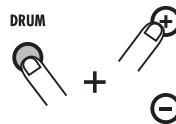

For information on MIDI channel setting, see page 67.

5. Press the [FUNCTION] key.

The MIDI receive channel is set for the track. The RT-223 produces sound according to the note numbers received via the [MIDI IN] connector. Program change messages can be used to switch drum kits and bass programs of the RT-223. For information on program change numbers and corresponding drum kits and bass programs, refer

to the appendix at the end of this manual.

Checking the remaining memory capacity

To display the remaining amount of free memory, proceed as follows.

1. Press the [FUNCTION] key followed by the [PATTERN] key.



The remaining amount of free memory is displayed (in percent). This display is for information only, it cannot be changed.

HINT

To increase the amount of free memory, delete patterns and songs that are no longer required.

2. To return to the previous mode, press the [FUNCTION] key or the [EXIT] key.

Turning the backlight off

You can use the RT-223 with the display backlight turned off.

Turn power to the RT-223 on while holding down the VALUE [-] key. The backlight will be turned off, and the unit consumes less power. This is convenient when remaining battery capacity is low.

Returning the RT-223 to the factory default condition (initialization)

You can return all data in the RT-223 to the factory default condition.

NOTE

Use this function with care, because it will erase all patterns and songs that have been recorded by the user. These cannot be restored.

1. Turn power to the RT-223 on while holding down the REC [●] key.

The indication "ALLINIT" flashes on the display.

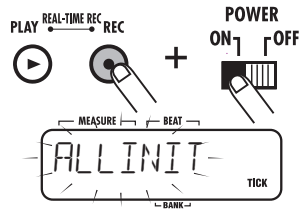

2. To go ahead with the initialization, press the REC [●] key once more. To cancel the procedure, press the [EXIT] key.

When initialization is carried out, all settings and data of the RT-223 are reset to the factory default condition, and then the unit starts up.

If the process was canceled, the RT-223 starts up normally.

HINT

If required, you can restore selected patterns (→ p. 32), drum kits (→ p. 52) or effect patches (→ p. 58) to the factory default condition.

Troubleshooting

Check the following items first if there seems to be a problem with the RT-223.

Symptom	Check	Remedy
No sound or very low volume	Is the specified AC adapter connected properly?	Make sure that the correct AC adapter or batteries are used.
	Are [R OUT] jack and [L/MONO OUT] jack connected correctly to the playback system?	Make connections as described in "Getting Connected" (page 6).
	Is there a problem with the cable?	Try using another cable.
	Is the connected playback system operating normally?	Check the system and make sure that the volume level is adjusted properly.
	Is volume of RT-223 set correctly?	Set [VOLUME] control to a suitable position.
Hitting a pad produces no sound or very low level sound	Are pad settings correct?	Use [FUNCTION] key and pad [+](PAD SENS) to set pad sensitivity (→ p. 67).
Sound is distorted or intermittent	Is output level of RT-223 set too high?	Set [VOLUME] control of RT-223 to a suitable position.
	Is COMP EQ effect output signal too high?	Set LEVEL parameter of COMP EQ effect to a suitable value.
Cannot record song/pattern	Is memory capacity limit reached?	Delete unneeded patterns and songs.
Operating foot switch FS01 has no effect	Is FS01 connected correctly to [FOOT SW] jack?	Make connections as described in "Getting Connected" (page 6).
	Are foot switch settings adequate?	Use [FUNCTION] key and pad 8 (FOOT SW) to set pad sensitivity (→ p. 65).
Simultaneous playback with MIDI components is not possible	Is MIDI receive function set to ON?	Use [FUNCTION] key and pad [0] (MIDI) to change setting from "Int" (MIDI clock receive disabled) to "Ext" (MIDI clock receive enabled).

RT-223 Appendix

RT-223 Product Specifications

Sampling Frequency	44.1 kHz
D/A Conversion	24-bit 8-times oversampling
Maximum Polyphony	18 voices
Resolution	96 clock pulses per quarter note
Tempo Range	40 - 250 BPM
Number of Recordable Note Events	32,000
Drum Sounds	213
Bass Sounds	12
Drum Kits	127
Rhythm Patterns	511
Songs	100
Number of Pads	13 (with velocity sensor)
Display	
Display Type	Custom LCD with 128 segments
External Connectors	
External Control Connector	FS01 input
MIDI	IN
Inputs/Outputs	
LINE IN	Standard stereo phone jack (Input impedance 10 kilohms, rated input level -10 dBm)
OUTPUT	
Line Out (L/MONO)	Standard phone jack
Line Out (R)	Standard phone jack (Output impedance 1 kilohm or less, rated output level -10 dBm)
Headphones	Mini phone jack, 50 mW (into 32 ohm load)
Dimensions	217.9 (W) x 182.6 (D) x 35.5 (H) mm
Weight	680 grams
Power Requirements	9 V DC, 300 mA (from AC adapter AD-0006) Batteries IEC R6 (size AA) x 4; continuous operation 8 hours or more
Supplied Accessories	Operation Manual

Reverb Module

Parameters											
EFFECT ON/OFF	HALL	PRE DLY	DECAY	EQ H	EQ L	DAMP	E/R MIX	DR SEND	BS SEND	KICKDRY	EFX LVL
		Produces concert hall type reverberation.									
EFFECT ON/OFF	ROOM	PRE DLY	DECAY	EQ H	EQ L	DAMP	E/R MIX	DR SEND	BS SEND	KICKDRY	EFX LVL
		Produces room type reverberation.									
EFFECT ON/OFF	SPRING	PRE DLY	DECAY	EQ H	EQ L	DAMP	KICKDRY	BS SEND	KICKDRY	EFX LVL	
		Simulates a spring reverb.									
EFFECT ON/OFF	PLATE	PRE DLY	DECAY	EQ H	EQ L	DAMP	KICKDRY	BS SEND	KICKDRY	EFX LVL	
		Simulates a plate reverb.									
EFFECT ON/OFF	DELAY	TIME	FB	DAMP	PAN	KICKDRY	BS SEND	KICKDRY	EFX LVL		
		Delay with up to 700 ms delay time.									
EFFECT ON/OFF	CHORUS	LFO TYP	DEPTH	RATE	PRE DLY	KICKDRY	BS SEND	KICKDRY	EFX LVL		
		Adds modulation and spread.									
EFFECT ON/OFF	FLANGER	DEPTH	RATE	FB	LFO SFT	KICKDRY	BS SEND	KICKDRY	EFX LVL		
		Adds an undulating sound with strong character.									

Parameter description

Parameter name	Setting range	Parameter description
EFFECT ON/OFF	ON, OFF	Controls effect ON/OFF for each patch.
TYPE	HALL, ROOM, SPRING, PLATE, DELAY, CHORUS, FLANGER	Selects from seven available types.
LFO TYP	Mn, St	Sets LFO phase to Mn (Mono) or St (Stereo).
LFO SFT	0 - 180	Sets the left/right phase difference.
DEPTH	0 - 10	Sets the effect depth.
RATE	CHORUS : 1 - 30 FLANGER : 1 - 30, t0 - t9, M1 - M4	Sets the effect rate. When set to "tx" or "Mx", rate is synchronized to rhythm tempo (see next page Table 1).
PRE DLY	CHORUS : 1 - 30 HALL, ROOM, SPRING, PLATE : 1 - 100	Sets the predelay.
TIME	1 - 700, t0 - t7	Sets the delay time in 1-ms steps. When set to "tx", delay time is synchronized to rhythm tempo (see next page Table 1).
FB	DELAY : 0 - 10 FLANGER : -10 - 10	Sets the feedback amount.
DAMP	0 - 10	Sets the high-range attenuation of the reverb sound and delay sound.
PAN	L10 - L1, 0, r1 - r10	Sets the stereo position of the delay sound.
DECAY	1 - 30	Sets the reverb time.
EQ H	-12 - 6	Controls the high-range level of the effect sound.
EQ L	-12 - 6	Controls the low-range level of the effect sound.
E/R MIX	0 - 30	Sets the level of the initial reflection.
KICKDRY	ON, OFF	Switches KICK (bass drum) effect processing for pad 0 ON/OFF.
DR SEND	0 - 100	Adjusts the drum effect sound send level.
BS SEND	0 - 100	Adjusts the bass effect sound send level.
EFX LVL	0 - 30	Sets the effect sound mix amount.

COMP EQ Module

Parameters														
EFFECT ON/OFF	MLT CMP	XOVER L	XOVER H	SENS H	SENS M	SENS L	MIX H	MIX M	MIX L	EQ H	EQ M	EQ L	BASS ON/OFF	LEVEL
		Divides the signal into three frequency bands and separately sets compressor and mix for each. Also includes 3-band equalizer.												
EFFECT ON/OFF	LO-FI	CHARA	COLOR	DIST	STONE	EFX LVL	DRY LVL	EQ H	EQ M	EQ L	BASS ON/OFF	LEVEL		
		Simulates low-fi sound. Also includes 3-band equalizer.												
EFFECT ON/OFF	RESONNC	DEPTH	FREQ	RATE	TYPE	RESO	EFX LVL	DRY LVL	EQ H	EQ M	EQ L	BASS ON/OFF	LEVEL	
		Resonance filter with LFO. Also includes 3-band equalizer.												

Parameter description

Parameter name	Setting range	Parameter description
EFFECT ON/OFF	ON, OFF	Controls effect ON/OFF for each patch.
TYPE	MLT CMP, LO-FI, RESONNC	Selects from three available types.
XOVER L	50 - 16000	Sets the division point for low/mid frequency bands.
XOVER H	50 - 16000	Sets the division point for mid/high frequency bands.
SENS H	0 - 24	Sets the compressor sensitivity in the high range.
SENS M	0 - 24	Sets the compressor sensitivity in the mid range.
SENS L	0 - 24	Sets the compressor sensitivity in the low range.
MIX H	OFF, -24 - 6	Sets the high range mix amount.
MIX M	OFF, -24 - 6	Sets the mid range mix amount.
MIX L	OFF, -24 - 6	Sets the low range mix amount.
CHARA	0 - 10	Sets the filter characteristic.
COLOR	1 - 10	Adjusts the sound color.
DIST	0 - 10	Adjusts the distortion.
STONE	0 - 10	Adjusts the tonal quality.
DEPTH	0 - 10	Sets the effect depth.
FREQ	1 - 30	Sets the LFO offset.
RATE	1 - 30, t0 - t9, M1 - M4	Sets the effect rate. When set to "tx" or "Mx", rate is synchronized to rhythm tempo (see Table 2).
TYPE	HPF, LPF, bPF	Selects the filter type.
RESO	1 - 30	Applies resonance to the effect.
EFX LVL	0 - 30	Sets the effect sound mix amount.
DRY LVL	0 - 30	Sets the original sound mix amount.
EQ H	-12 - 12	Applies boost/cut to the high range.
EQ M	-12 - 12	Applies boost/cut to the mid range.
EQ L	-12 - 12	Applies boost/cut to the low range.
BASS ON/OFF	ON, OFF	Switches bass effect processing ON/OFF.
LEVEL	1 - 30	Sets the patch output level.

[Table 1 Synchronization setting for RATE and TIME parameter]

Setting value	Frequency	Setting value	Frequency	Setting value	Frequency
t0	Thirty-second note	t5	Half note triplet	M1	Full note
t1	Sixteenth note	t6	Dotted eighth note	M2	Full note x 2
t2	Quarter note triplet	t7	Quarter note	M3	Full note x 3
t3	Dotted sixteenth note	t8	Dotted quarter note	M4	Full note x 4
t4	Eighth note	t9	Half note		

PATCH LIST

COMP EQ

NO.	SECTION	NAME	Comment
0	COMP	STANDRD	Standard compressor sound
1		BOTTOM	Strong compression of low range
2		FULLRG	Strong compression of full frequency range
3		CRUSH	Strong compression of mid range
4		POWER	Enhance overall punch
5		EQBOOST	Compressor sound for enhancing mid range
6		EQHIBST	Compressor sound for enhancing high range
7		EQHICUT	EQ for cutting high range
8		EQLIGHT	EQ for making light sound
9		EQTIGHT	EQ for making tight sound
10		LO&HI	Compressor sound for enhancing high and low range
11	NATURAL	Compressor sound with wide range of use	
12	LO-FI	FATDRUM	Simulate sound of big drum
13		LO-FI	Lo-fi sound
14		RETRO	Make a 1930's sound
15		8-Bit	Simulate old low bit rhythm machine
16	ANGRY	Add a rough feeling over all	
17	RESONNC	RAVEREZ	Special sweep effect using sharp filter
18		HiPASS	High-pass filter with resonance
19		RAY-GUN	FX sound of the laser gun style

REVERB

NO.	SECTION	NAME	Comment
0	ROOM	STUDIO	Simulate reverberation of a rehearsal studio
1		BRIGHT	Room reverb with a hard tonal quality
2		DARK	Room reverb with a mild tonal quality
3	GATE	TUNNEL	Simulate reverberation of a tunnel
4		GATE 1	Gate reverb sound
5	HALL	GATE 2	Deep gate reverb sound
6		SM HALL	Simulate reverberation of a small-sized hall
7		MIDHALL	Simulate reverberation of a middle-sized hall
8		BIGHALL	Simulate reverberation of a large-sized hall
9		CLEAR	Simulate bright reverb of a concert hall
10		SOFT	Hall reverb with a mild tonal quality
11		BUDOKAN	Simulate reverberation at Budokan in Tokyo
12	PLATE	PLATE	Plate reverb simulation
13		SHARPPL	Sharp reverb
14	DELAY	SHORTPL	Short reverb
15		SLAP	short delay
16		SHORT	16th-note delay in sync with rhythm tempo
17		REPEAT	8th-note delay in sync with rhythm tempo
18		TRIPLET	Dotted 16th-note delay in sync with rhythm tempo
19		JAMMING	Dotted 8th-note delay in sync with rhythm tempo
20		SYNCHRO	Dotted 8th-note delay in sync with rhythm tempo
21		ACCENT	4th-triple-note delay in sync with rhythm
22		RHYTHM	Half-triple-note delay in sync with rhythm
23		CHORUS	AIR-CHO
24	FLANGER	FLANGER	Standard flanger for drum sound
25	DEMO	BIGVERB	Deep reverb used for demonstration song
26		MINVERB	Shallow reverb used for demonstration song

DRUM KIT LIST

Category	NAME	No.
Rock	BASIC	0
	REZROCK	1
	LIVE	2
	MODERN	3
	ROCKET	4
R&B	SNAPPY	5
	ROOM	6
	ACUSTIK	7
	STUDIO	8
	PUNCH	9
	AMBIENT	10
Voice	BEATBX1	11
	BEATBX2	12
	BEATBX3	13
	BEATBX4	14
	BEATBX5	15
Funk	SUPRFLY	16
	FUNKY	17
	DRYFUNK	18
	FUNKSTR	19
	FUNKIFY	20
	BIGFUNK	21
	CRACKER	22
ZOOM Classic	LIVE ZM	23
	EPIC ZM	24
	REAL ZM	25
	SNAP ZM	26
	MOD ZM	27
HipHop	FUNK ZM	28
	HIPHOP	29
	STREET	30
	HOMIE	31
Dance	RAPPER	32
	SYNTECH	33
	POWER	34
	ELECTRO	35
	KICKER	36
	REZNANZ	37

Category	NAME	No.
Jazz	BRUSH1	38
	BRUSH2	39
	BRUSH3	40
	BRUSH4	41
	BRUSH5	42
Pop	POPROCK	43
	LITEPOP	44
	DRY POP	45
	HIT POP	46
	AMBIPOP	47
	SUPRPOP	48
Hard Rock	HARDROK	49
	RESOROK	50
	BIGBEAT	51
	HARD RM	52
	HEAVY	53
Fusion	B-FUSON	54
	L-FUSON	55
	X-FUSON	56
	S-FUSON	57
	T-FUSON	58
	D-FUSON	59
World	LATIN 1	60
	LATIN 2	61
	METAL	62
	REGGAE	63
	AFRICAN	64
	TURKISH	65
	INIDAN	66
	ASIAN	67
	SFX 1	68
SFX 2	69	

The BEATBX sounds have been supplied by Big Fish Audio. Big Fish Audio is the world's largest producer of loops and samples. Their library products are used by top music producers across most musical styles and are an affordable resource for music production. For more information see them on the web at www.bigfishaudio.com.



Big Fish Audio
11003 Penrose Street, Ste C
Sun Valley, CA 91352 USA
Phone (818) 768-6115
@Fax (818) 768-4117
www.bigfishaudio.com
info@bigfishaudio.com

BASS PROGRAM LIST

No.	PC#	DISPLAY
0	0,12,24,34,41,53,65,77,89,101,113,125	FINGER
1	1,13,25,35,42,54,66,78,90,102,114,126	BRIGHT
2	2,14,26,37,43,55,67,79,91,103,115,127	SLAP
3	3,15,27,33,44,56,68,80,92,104,116	ACUSTIK
4	4,16,28,38,45,57,69,83,93,105,117	MUTE
5	5,17,29,36,46,58,70,84,94,106,118	DARK
6	6,18,30,39,47,59,71,85,95,107,119	SYNTH1
7	7,19,31,40,48,60,72,86,96,108,120	SYNTH2
8	8,20,32,49,61,73,87,97,109,121	HARMONX
9	9,21,50,62,74,88,98,110,122	LO-SINE
10	10,22,51,63,75,81,99,111,123	SQUARE
11	11,23,52,64,76,82,100,112,124	SAW

DRUM PAD NOTE# LIST

PAD No	PAD NAME	BANK1	BANK2	BANK3
PAD1	KICK	36	35	61
PAD2	TOM1	50	48	64
PAD3	SNARE	38	40	60
PAD4	TOM2	47	45	62
PAD5	CLOSED HAT	42	44	68
PAD6	TOM3	43	41	63
PAD7	OPEN HAT	46	54	67
PAD8	CRASH	49	57	66
PAD9	EXTRA 1	37	70	71
PAD10	RIDE	51	59	65
PAD11	EXTRA 2	39	52	72
PAD12	EXTRA CYMBAL	53	55	69
PAD13	EXTRA 3	56	58	73

MIDI NOTE # LIST

Note No	DRUM KIT		BASS Programs
	INST No	INST NAME	
24			From note 0 BASS range ↓
25			
26			
27	349	HighQ	
28	290	Slap	
29	358	Scratch1	
30	359	Scratch2	
31	275	ShorStk	
32	318	SquarCik	
33	321	MetroCik	
34	329	MtrBell	
35			PAD BANK 1 ? PAD BANK 3
36			
37			
38			
39			
66			
67			
68			
69			
70			
71			
72			
73			
74	74	GuiroL1	
75	75	Claves1	
76	76	WoodBkKH	
77	77	WoodBkL	
78	78	CuicaHi	
79	79	CuicaLo	
80	80	MTrangl	
81	81	OpTrangl	
82	82	Shaker1	
83	83	JBell1	
84	84	Beltre1	
85	85	Castnet1	
86	86	MtSurdo	
87	87	OpSurdo	
88			

The highest note number that can be produced depends on the bass program.
 The PAD BANK 1 - 3 INST No, INST NAME depend on the kit.
 The range of note numbers that can be produced by the pads of the RT-323 is 12 - 63.

INSTRUMENT LIST

Category	AbsNo	No.	Category	AbsNo	No.	Category	AbsNo	No.	Category	AbsNo	No.
Kick	TIGHT	0	Snare	ROLL1	27	HiHat	OPANLG1	9	Global	VIBSLAP	9
	ACO-BD1	1		ROLL2	28		OPANLG2	10		HIBONGO	10
	ACO-BD2	2		VO-SD1	29		CLSSTDO	11		LOBONGO	11
	CLASSC1	3		VO-SD2	30		CLSBEND	12		MTHICNG	12
	CLASSC2	4		VO-SD3	31		OPBEND	13		HICNG1	13
	STD-BD1	5		VO-SD4	32		PEDACO	14		HICNG2	14
	STD-BD2	6		VO-SD5	33		CLSHMN	15		LOCNG	15
	STD-BD3	7		LIVETM1	0		OPHMN	16		HITIMBA	16
	PUNCH	8		LIVETM2	1		LIVECYM	0		LOTIMBA	17
	ATTK-BD	9		LIVETM3	2		CRSH'17	1		HIAGOGO	18
	ANALOG1	10	DRY-TM1	3	CRSH'20	2	LOAGOGO	19			
	ANALOG2	11	DRY-TM2	4	CRSH3	3	CABASA	20			
	DIGALG1	12	DRY-TM3	5	SPLASH1	4	MARACAS	21			
	DIGALG2	13	808_1	6	SPLASH2	5	WHISL1	22			
	LIVE-BD	14	808_2	7	RIDE1	6	WHISL2	23			
	STDO-BD	15	808_3	8	RIDE2	7	GUIROS	24			
	RESO-BD	16	ACO-TM1	9	CUP1	8	GUIROL	25			
	HUGE	17	ACO-TM2	10	CUP2	9	CLAVES	26			
	STAGE	18	ACO-TM3	11	CRSH-B	10	WDBLKH	27			
	DEEP-BD	19	SYNTH	12	RIDE-B	11	WDBLKL	28			
	HARD-BD	20	POPHI1	13	CHINA	12	MTCUICA	29			
	BEND-BD	21	POPHI2	14	VO-CYM	13	OPCUICA	30			
	BD-DRY1	22	POPMID	15	EXRIM1	0	MTRRAGL	31			
	BD-DRY2	23	POPLO	16	EXRIM2	1	OPTRAGL	32			
	VO-BD1	24	STDOTM1	17	EXRIM3	2	SHAKER	33			
	VO-BD2	25	STDOTM2	18	EXCWBL1	3	JGBELL	34			
VO-BD3	26	STDOTM3	19	EXCWBL2	4	BELLTR	35				
Snare	LIVE-SD	0	Toms	AMBI1	20	Extra	EXCLAP1	5	SFX	CSTNET	36
	HIGHSD1	1		AMBI2	21		EXCLAP2	6		MTRSDO	37
	TIGHT	2		AMBI3	22		EXSN909	7		OPSRDO	38
	ANALOGM	3		HARDTM1	23		EXTMBRB	8		FLITSWP	0
	ANALOGS	4		HARDTM2	24		EXCLAPB	9		GAMELAN	1
	DIGALGM	5		HARDTM3	25		C'MON	10		BASSSLD	2
	DIGALGS	6		BENDTM1	26		SCRATCH	11		BELL	3
	POWER	7		BENDTM2	27		H RIM01	12		OODAIKO	4
	ROOM	8		BENDTM3	28		DJEMBE1	13		CUDAIKO	5
	SNAP1	9		GATE1	29		DJEMBE2	14		OEDO	6
	SNAP2	10	GATE2	30	DJEMBE3	15	TEMPLE	7			
	FUNK	11	GATE3	31	DUMBEK1	16	MOKUGYO	8			
	STD-SD	12	ELECTO1	32	DUMBEK2	17	CLOCK	9			
	REGAE	13	ELECTO2	33	DUMBEK3	18	UFO	10			
	ATTK-SD	14	ELECTO3	34	TABLA1	19	D-CLOSE	11			
	DRY-SD	15	BRSHTMH	35	TABLA2	20	D-OPEN	12			
	DRY-SDH	16	BRSHMTMM	36	TABLA3	21	KISHIMI	13			
	RESO-SD	17	BRSHTML	37	TABLA4	22	SLIDING	14			
	DEEP-SD	18	CLS14'	0	HIGH Q	0	ENGINE	15			
	BASIC	19	CLS14'2	1	SLAP	1	SONAR	16			
	BRSTAP	20	CLS.LIVE	2	SCRCH1	2	SPACE	17			
	BRSSWIP	21	OPLIVE	3	SCRCH2	3	SCENCE	18			
	BRSSWEP	22	CLCLEAR	4	STICKS	4	MAJOR7	19			
	BRSSMT	23	OPCLEAR	5	SQRCLK	5	MINOR7	20			
	BRSSSLP	24	CLSANLG	6	MTRCLK	6					
	SD-DRY1	25	CLSDGAN	7	MTRBELL	7					
	SD-DRY2	26	OPDGAN	8	TAMBRIN	8					

PRESET PATTERN LIST

	No.	Name	DrKit	BassPG	BPM
DemoPattern	0	ROCK	0	0	120
	1	HARDROK	23	1	120
	2	RnB	26	5	138
	3	POP	44	0	120
	4	FUNK	19	2	112
	5	HIP	32	7	98
	6	BEATBOX	11	9	84
	7	HOUSE	36	7	120
	8	FUSION	48	4	124
	9	DnB	33	1	150
	10	BLUS	25	4	120
	11	BRUSH	42	3	120
	12	JAZZ	41	3	120
	13	AFRO	64	5	123
14	MIDEAST	65	5	122	
	15	8BEAT01	0	1	--
	16	8BEAT02	0	5	--
	17	8BEAT03	0	1	--
	18	8BEAT04	1	0	--
	19	8BEAT05	1	0	--
	20	8BEAT06	1	0	--
	21	8BEAT07	1	0	--
	22	8BEAT08	2	1	--
	23	8BEAT09	2	1	--
	24	8BEAT10	2	1	--
	25	8BEAT11	2	1	--
	26	8BEAT12	57	0	--
	27	16BEAT1	54	0	--
	28	16BEAT2	54	0	--
	29	16BEAT3	54	0	--
	30	16BEAT4	54	0	--
	31	16BEAT5	55	0	--
	32	16BEAT6	55	1	--
	33	16BEAT7	55	1	--
	34	16BEAT8	57	0	--
	35	16BEAT9	57	0	--
	36	ROCK01	4	1	120
	37	ROCK02	4	1	140
	38	ROCK03	4	1	107
	39	ROCK04	19	1	136
	40	ROCK05	19	1	120
	41	ROCK06	19	1	115

	No.	Name	DrKit	BassPG	BPM	
	42	ROCK07	19	1	117	
	43	ROCK08	5	1	117	
	44	ROCK09	50	1	120	
	45	ROCK10	28	1	136	
	46	ROCK11	28	1	112	
	47	ROCK12	28	1	140	
	48	ROCK13	7	1	120	
	49	ROCK14	10	1	120	
	50	ROCK15	1	1	120	
	51	ROCK16	2	1	120	
	52	ROCK17	53	0	116	
	53	ROCK18	4	1	92	
	54	ROCK19	53	0	96	
	55	ROCK20	53	0	96	
	56	ROCK21	27	1	137	
	57	ROCK22	27	1	112	
	58	ROCK23	27	1	103	
	59	ROCK24	27	1	120	
	60	ROCK25	26	1	99	
	61	ROCK26	26	1	96	
	62	ROCK27	26	1	132	
	63	ROCK28T	2	1	120	
	SONG	64	ROCK1VA	0	0	120
		65	ROCK1FA	0	0	120
		66	ROCK1VB	0	0	120
	SONG	67	ROCK1FB	0	0	120
		68	ROCK2VA	49	1	110
		69	ROCK2FA	49	1	110
	SONG	70	ROCK2VB	49	1	110
		71	ROCK2FB	49	1	110
		72	ROCK3VA	25	4	124
	SONG	73	ROCK3FA	25	4	124
		74	ROCK3VB	25	4	124
		75	ROCK3FB	25	4	124
SONG	76	ROCK4VA	0	0	130	
	77	ROCK4FA	0	0	130	
	78	ROCK4VB	0	0	130	
	79	ROCK4FB	0	0	130	
	80	ROCK4BR	0	0	130	
	81	HRK 01	49	1	130	
	82	HRK 02	49	1	113	
	83	HRK 03	10	1	96	

	No.	Name	DrKit	BassPG	BPM
	84	HRK 04	4	1	120
	85	HRK 05	52	1	121
	86	HRK 06	24	1	136
	87	HRK 07	59	1	120
SONG	88	HRK 1VA	49	1	120
	89	HRK 1FA	49	1	120
	90	HRK 1VB	49	1	120
SONG	91	HRK 1FB	49	1	120
	92	HRK 2VA	53	1	115
	93	HRK 2FA	53	1	115
SONG	94	HRK 2VB	53	1	115
	95	HRK 2FB	53	1	115
	96	MTL 01	24	1	98
SONG	97	MTL 02	24	1	103
	98	MTL 03	24	1	112
	99	MTL 04	59	1	150
SONG	100	MTL 1VA	23	5	128
	101	MTL 1FA	23	5	128
	102	MTL 1VB	23	5	128
SONG	103	MTL 1FB	23	5	128
	104	THRS01	21	1	135
	105	THRS02	21	1	186
SONG	106	PUNK01	7	1	160
	107	PUNK02	7	0	128
SONG	108	TP 1VA	21	1	129
	109	TP 1FA	21	1	129
	110	TP 1VB	21	1	129
	111	TP 1FB	21	1	129
SONG	112	POP 01	48	0	142
	113	POP 02	0	0	108
	114	POP 03	44	0	120
	115	POP 04	48	0	112
	116	POP 05T	35	5	80
	117	POP 06	26	0	100
	118	POP 07	43	4	117
	119	POP 08	7	4	120
	120	POP 09	18	0	120
	121	POP 10	18	0	120
	122	POP 11T	55	0	140
	SONG	123	POP 1VA	44	1
124		POP 1FA	44	1	126
125		POP 1VB	44	1	126
126		POP 1FB	44	1	126
SONG	127	POP 2VA	48	4	134
	128	POP 2FA	48	4	134
	129	POP 2VB	48	4	134

	No.	Name	DrKit	BassPG	BPM
SONG	130	POP 2FB	48	4	134
SONG	131	POP 3VA	44	1	120
	132	POP 3FA	44	1	120
	133	POP 3VB	44	1	120
	134	POP 3FB	44	1	120
SONG	135	RnB 01	49	5	138
	136	RnB 02	9	0	100
	137	RnB 03	7	1	120
	138	RnB 04	6	0	168
	139	RnB 05	9	2	100
	140	RnB 06	17	0	120
	141	RnB 07	9	0	92
	142	RnB 08	9	0	116
	143	RnB 09	20	2	104
	SONG	144	RnB 1VA	9	7
145		RnB 1FA	9	7	130
146		RnB 1VB	9	7	130
147		RnB 1FB	9	7	130
SONG	148	FUNK01	16	2	112
	149	FUNK02	19	2	120
	150	FUNK03	16	2	112
	151	FUNK04	18	4	98
	152	FUNK05	20	0	94
	153	FUNK06	16	0	92
	154	FUNK07	18	0	99
	155	FUNK08	19	5	112
	156	FUNK09	20	5	125
	157	FUNK10	16	0	92
	158	FUNK11	16	0	110
SONG	159	FUNK1VA	16	2	120
	160	FUNK1FA	16	2	120
	161	FUNK1VB	16	2	120
	162	FUNK1FB	16	2	120
SONG	163	FUNK2VA	19	0	118
	164	FUNK2FA	19	0	118
	165	FUNK2VB	19	0	118
	166	FUNK2FB	19	0	118
SONG	167	HIP 01	36	7	98
	168	HIP 02	36	5	91
	169	HIP 03	35	3	88
	170	HIP 04	32	5	96
	171	HIP 05	36	9	112
	172	HIP 06	36	5	112
	173	HIP 07	31	7	103
	174	HIP 08	29	0	92
	175	HIP 09	34	5	99

	No.	Name	DrKit	BassPG	BPM
	176	HIP 10	33	9	85
	177	HIP 11	36	7	96
	178	HIP 12	36	7	116
	179	HIP 13	31	5	148
	180	HIP 14	36	5	107
	181	HIP 15	32	3	120
	182	HIP 16	31	7	98
	183	HIP 17	31	7	102
	184	HIP 18	20	5	99
	185	HIP 19	34	7	91
	186	HIP 20	34	6	88
	187	HIP 21	30	7	88
	188	HIP 22	30	4	136
SONG	189	HIP 1VA	33	7	96
	190	HIP 1FA	33	7	96
	191	HIP 1VB	33	7	96
	192	HIP 1FB	33	7	96
	193	HIP 1VC	33	7	96
	194	HIP 1VD	33	7	96
SONG	195	HIP 2VA	29	4	110
	196	HIP 2VB	29	4	110
	197	HIP 2FB	29	4	110
	198	HIP 2VC	29	4	110
199	HIP 2VD	29	4	110	
SONG	200	HIP 3VA	29	5	112
	201	HIP 3VB	29	5	112
	202	BEATBX1	12	9	88
	203	BEATBX2	13	9	99
	204	BEATBX3	14	9	102
	205	BEATBX4	15	9	112
	206	DANCE1	35	5	-
	207	DANCE2	34	0	111
	208	DANCE3	29	7	102
	209	DANCE4	34	5	120
	210	DANCE5	29	6	180
	211	DANCE6	35	7	103
	212	DANCE7	34	7	120
SONG	213	DANC1VA	29	7	110
	214	DANC1FA	29	7	110
	215	DANC1VB	29	7	110
	216	DANC1FB	29	7	120
SONG	217	DANC2VA	35	7	120
	218	DANC2FA	35	7	120
	219	DANC2VB	35	7	120
	220	DANC2FB	35	7	120

	No.	Name	DrKit	BassPG	BPM
	221	HOUSE1	35	9	126
	222	HOUSE2	35	7	120
	223	HOUSE3	35	5	120
SONG	224	HOUS1VA	35	7	120
	225	HOUS1FA	35	7	120
	226	HOUS1VB	35	7	120
	227	HOUS1FB	35	7	120
	228	TECH01	33	9	148
	229	TECH02	33	10	125
	230	TECH03	33	7	125
	231	TECH04	33	4	160
	232	TECH05	33	3	164
	233	TECH06	35	6	118
	234	TECH07	56	7	140
	235	TECH08	31	7	136
	236	TECH09	33	7	119
	237	TECH10	29	6	127
SONG	238	TECH1VA	33	7	135
	239	TECH1FA	33	7	135
	240	TECH1VB	33	7	135
	241	TECH1FB	33	7	135
	242	FUS 01	58	2	120
	243	FUS 02	47	0	113
	244	FUS 03	59	1	105
	245	FUS 04	55	1	120
	246	FUS 05	58	5	120
	247	FUS 06	16	0	120
	248	FUS 07	58	0	94
SONG	249	FUS 1VA	55	2	110
	250	FUS 1FA	55	2	110
	251	FUS 1VB	55	2	110
	252	FUS 1FB	55	2	110
SONG	253	FUS 2VA	54	0	124
	254	FUS 2FA	54	0	124
	255	FUS 2VB	54	0	124
	256	FUS 2FB	54	0	124
SONG	257	FUS 3VA	57	4	118
	258	FUS 3FA	57	4	118
	259	FUS 3VB	57	4	118
	260	FUS 3FB	57	4	118
SONG	261	INDT1VA	24	6	134
	262	INDT1FA	24	6	134
	263	INDT1VB	24	6	134
	264	INDT1FB	24	6	134
	265	DnB 01	38	0	150

	No.	Name	DrKit	BassPG	BPM
	266	DnB 02	56	9	150
	267	DnB 03	29	9	144
	268	DnB 04	31	9	154
	269	DnB 05	36	9	154
SONG	270	DnB 1VA	56	7	150
	271	DnB 1FA	56	7	150
	272	DnB 1VB	56	7	150
	273	DnB 1FB	56	7	150
	274	TRIP01	45	9	120
	275	TRIP02	45	5	75
	276	TRIP03	45	9	97
	277	TRIP04	48	7	101
	278	AMB 01	35	5	106
	279	AMB 02	33	5	98
	280	AMB 03	45	5	157
	281	AMB 04	9	3	89
SONG	282	AMB 1VA	9	5	114
	283	AMB 1FA	9	5	114
	284	AMB 1VB	9	5	114
	285	AMB 1FB	9	5	114
	286	BALD01	57	5	76
	287	BALD02	58	5	75
	288	BALD03	58	5	65
	289	BALD04	25	5	65
	290	BALD05	25	5	108
	291	BALD06	25	5	99
	292	BALD07	4	5	80
	293	BALD08	25	0	75
	294	BALD09	58	0	110
	295	BALD10	25	5	105
	296	BALD11T	26	0	112
SONG	297	BALD1VA	25	5	96
	298	BALD1FA	25	5	96
	299	BALD1VB	25	5	96
	300	BALD1FB	25	5	96
	301	BLUSE01	7	0	72
	302	BLUSE02	17	0	120
	303	BLUSE03	25	0	111
	304	BLUSE04	0	0	91
	305	BLUSE05	25	4	105
SONG	306	BLUS1VA	7	5	136
	307	BLUS1FA	7	5	136
	308	BLUS1VB	7	5	136
	309	BLUS1FB	7	5	136
	310	CNTRY01	57	0	-
	311	CNTRY02	48	0	120

	No.	Name	DrKit	BassPG	BPM
	312	CNTRY03	56	0	120
	313	CNTRY04	0	4	95
	314	CNTRY05	51	0	115
SONG	315	CNTR1VA	51	0	118
	316	CNTR1FA	51	0	118
	317	CNTR1VB	51	0	118
	318	CNTR1FB	51	0	118
	319	BRUSH1	39	3	120
	320	BRUSH2	39	3	120
	321	BRUSH3	40	3	120
	322	BRUSH4	41	3	120
	323	JAZZ01	39	3	102
	324	JAZZ02	7	3	72
	325	JAZZ03	38	3	111
	326	JAZZ04	39	3	92
	327	JAZZ05	40	3	105
	328	JAZZ06	0	0	136
SONG	329	JAZZ1VA	41	3	136
	330	JAZZ1FA	41	3	136
	331	JAZZ1VB	41	3	136
	332	JAZZ1FB	41	3	136
	333	SHFL01	7	4	125
	334	SHFL02	51	4	120
	335	SHFL03	51	1	122
	336	SHFL04	23	0	120
	337	SHFL05	54	1	120
SONG	338	SHFL1VA	7	4	115
	339	SHFL1FA	7	4	115
	340	SHFL1VB	7	4	115
	341	SHFL1FB	7	4	115
	342	SKA 01	44	4	160
	343	SKA 02	44	5	1441
	344	SKA 03	44	4	160
	345	SKA 04	44	4	144
	346	REGGAE1	63	5	132
	347	REGGAE2	63	2	161
	348	REGGAE3	63	5	129
	349	REGGAE4	63	5	150
SONG	350	REGG1VA	63	5	132
	351	REGG1VB	63	5	132
	352	REGG1FA	63	5	132
	353	REGG1FB	63	5	132
	354	AFRO01	18	0	123
	355	AFRO02	60	4	98
	356	AFRO03	60	1	115
	357	AFRO04	18	0	11

	No.	Name	DrKit	BassPG	BPM
	358	AFRO05	64	0	106
	359	AFRO06	64	0	92
	360	AFRO07	64	0	116
SONG	361	AFRO1VA	60	0	107
	362	AFRO1FA	60	0	107
	363	AFRO1VB	60	0	107
	364	AFRO1FB	60	0	107
	365	LATIN01	60	0	116
	366	LATIN02	61	0	130
	367	LATIN03	62	5	118
	368	LATIN04	61	0	88
	369	LATIN05	60	4	109
	370	LATIN06	7	0	150
	371	LATIN07	61	7	141
	372	LATIN08	61	3	104
	373	LATIN09	60	0	100
	374	LATIN10	60	0	78
	375	LATIN11	7	5	109
SONG	376	LATN1VA	7	5	126
	377	LATN1FA	7	5	126
	378	LATN1VB	7	5	126
	379	LATN1FB	7	5	126
SONG	380	LATN2VA	61	0	112
	381	LATN2FA	61	0	112
	382	LATN2VB	61	0	112
	383	LATN2FB	61	0	112
	384	MIDEST1	65	5	122
	385	MIDEST2	65	5	122
	386	MIDEST3	65	5	112
SONG	387	MIDE1VA	65	5	118
	388	MIDE1FA	65	5	118
	389	MIDE1VB	65	5	118
	390	MIDE1FB	65	5	118
	391	TURKSH1	65	0	100
	392	TURKSH2	65	0	100
	393	AFRICA1	64	0	89
	394	AFRICA2	64	0	95
	395	AFRICA3	64	0	108
	396	AFRICA4	64	0	120
	397	INDIAN1	66	0	120
	398	INDIAN2	66	0	100
	399	COUNT	46	0	--
	400	INTRO01	44	1	--

	No.	Name	DrKit	BassPG	BPM
	401	INTRO02	1	0	--
	402	INTRO03	49	1	--
	403	INTRO04	2	0	--
	404	INTRO05	3	0	--
	405	INTRO06	0	0	--
	406	INTRO07	0	0	--
	407	INTRO08	7	4	--
	408	INTRO09	16	2	--
	409	INTRO10	1	0	--
	410	INTRO11	9	7	--
	411	INTRO12	41	3	--
	412	INTRO13	39	0	--
	413	INTRO14	7	5	--
	414	INTRO15	61	5	--
	415	INTRO16	53	7	--
	416	ENDING1	0	0	--
	417	ENDING2	16	2	--
	418	ENDING3	10	2	--
	419	ENDING4	7	4	--
	420	ENDING5	33	7	--
	421	ENDING6	43	1	--
	422	ENDING7	61	5	--
	423	ENDING8	43	3	--
	424	ENDING9	7	5	--
	425	ENDNG10	9	7	--
	No.	Name	DrKit	BassPG	PAD#
	426	GRVARP1	-	8	PAD2
	427	GRVARP2	-	8	PAD4
	428	GRVBAS1	-	0	PAD13
	429	GRVBAS2	-	1	PAD9
	430	GRVBAS3	-	4	PAD12
	431	GRVBAS4	-	2	PAD11
	432	GRVPRC1	60	-	PAD6
	433	GRVPRC2	64	-	PAD10
	434	GRVDRM1	22	-	PAD1
	435	GRVDRM2	18	-	PAD5
	436	GRVDRM3	35	-	PAD7
	437	GRVDRM4	0	-	PAD8
	438	GRVSNFL	0	-	PAD3
	439	ALLMUTE	-	-	--

PRESET SONG PAD PARAMETER

No.0 RCK TMP		
Pattern	ROOT	Next
407	E	P02
64	A	P01
64	E	P02
64	B	P03
65	E	F06
66	A	P05
66	E	P06
66	B	P07
67	E	F02
0	E	P09
80	G	F02
0	F	P11
416	E	Stp

No.3 HRK TMP		
Pattern	ROOT	Next
403	A	P02
88	D	P01
88	A	P02
88	E	P03
89	A	F06
90	D	P05
90	A	P06
90	E	P07
91	A	F02
70	E	P09
418	G	P02
70	F	P11
418	A	stp

No.6 JZZ TMP		
Pattern	ROOT	Next
411	F#	P02
329	D#	P01
329	F#	P02
329	F	P03
330	F#	F06
331	D#	P05
331	F#	P06
331	F	P07
332	F#	F02
322	D#	P09
322	F#	P10
322	E	F11
423	F#	stp

No.9 RLL TMP		
Pattern	ROOT	Next
400	A	P02
131	D	P01
131	A	P02
131	E	P03
132	A	F06
133	D	P05
133	A	P06
133	E	P07
134	A	F02
123	D	P09
124	A	F02
123	E	P11
421	A	stp

No.1 FNK TMP		
Pattern	ROOT	Next
408	D	P02
159	G	P01
159	D	P02
159	A	P03
160	D	F06
161	G	P05
161	D	P06
161	A	P07
162	D	F02
148	D	P11
417	D	P02
148	G	P09
417	D	stp

No.4 LTN TMP		
Pattern	ROOT	Next
414	G	P02
376	A#	P01
376	G	P02
376	C	P03
377	G	F06
379	A#	P05
378	G	P06
379	C	P07
379	G	F02
375	F	P09
377	G	F12
375	G	P11
422	G	stp

No.7 RnB TMP		
Pattern	ROOT	Next
410	F#	P02
144	A	P01
144	F#	P02
144	B	P03
145	F#	F06
146	A	P05
146	F#	P06
146	B	P07
147	F#	F02
144	E	P09
145	B	F11
419	F#	P00
419	F#	stp

No.2 HIP TMP		
Pattern	ROOT	Next
415	E	P02
189	E	P01
189	E	P02
189	E	P03
190	E	F06
191	E	P05
191	E	P06
191	E	P07
192	E	F02
193	E	P09
190	E	F02
194	E	P11
420	E	stp

No.5 SHL TMP		
Pattern	ROOT	Next
405	C	P02
338	D	P01
338	C	P02
338	D#	P03
339	C	F06
340	D#	P05
340	C	P06
340	F	P07
341	D	F02
333	C	P09
333	F	P10
333	D#	P11
419	C	stp

No.8 BLS TMP		
Pattern	ROOT	Next
413	E	P02
306	A	P01
306	E	P02
306	B	P03
307	E	F06
308	A	P05
308	E	P06
308	B	P07
309	E	F02
306	D	P11
307	D	F02
306	G	P09
424	E	stp

MIDI Implementation

ZOOM Corporation

TOKYO, JAPAN

1. Recognized Messages

Status	1st	2nd	Description
8nH	kk	vv	Note Off kk: note number vv: velocity will be ignored
9nH	kk	00H	Note Off kk: note number
9nH	kk	vv	Note On kk: note number vv: velocity
BnH	0BH	vv	Channel Volume vv: volume value
BnH	11H	vv	Channel Expression vv: expression value
BnH	78H	xx	All Sounds Off
BnH	7BH	xx	All Notes Off
CnH	pp		Program Change pp: program number (See Note 1)
EnH	ll	hh	Pitch Bend Change hhll: pitch bend value
F2H	sl	sh	Song Position Pointer shsl: song position (See Note 2)
F3H	ss		Song Select ss: song number 0-99
F8H			Timing Clock
FAH			Start
FBH			Continue
FCH			Stop

NOTE: n = MIDI Channel Number (0000 - 1111)

1. Relationship between Program Numbers and Kit Numbers are assigned as "Kits and Program List" attached.
2. SongPositionPointer for a pattern , new location is wrapped around the bar length of the pattern.
3. Note On messages can be recorded into a pattern.

2. Transmitted Messages

NONE.

3. System Exclusive Messages

No SysEx messages are recognized/transmitted.

MIDI Implementation Chart

[MultiTrack Rhythm Machine]
 Model RhythmTrak RT-223 MIDI Implementation Chart

Date : 30.Nov.,2004
 Version :1.00

Function ...	Transmitted	Recognized	Remarks
Basic Channel	Default Changed	1-16 1-16	Memorized
Mode	Default Messages Altered	3 *****	
Note Number	True voice	0-127 *****	
Velocity	Note ON Note OFF	o x	
After Touch	Key's Ch's	x x	
Pitch Bend		o	
Control Change		7 11 120	Volume Expression All Sounds Off
Prog Change	True #	o 0-127 *****	
System Exclusive		x	
System Common	Song Pos Song Sel Tune	o o x	
System Real Time	Clock Commands	o o	
Aux Messages	Local ON/OFF All Notes OFF Active Sense Reset	x o x x	
Notes	No messages will be transmitted.		

Mode 1 : OMNI ON, POLY
 Mode 3 : OMNI OFF, POLY

Mode 2 : OMNI ON, MONO
 Mode 4 : OMNI OFF, MONO

o : Yes
 x : No

The FCC regulation warning (for U.S.A.)

This equipment has been tested and found to comply with the limits for a Class B digital device, pursuant to Part 15 of the FCC Rules. These limits are designed to provide reasonable protection against harmful interference in a residential installation. This equipment generates, uses, and can radiate radio frequency energy and, if not installed and used in accordance with the instructions, may cause harmful interference to radio communications. However, there is no guarantee that interference will not occur in a particular installation. If this equipment does cause harmful interference to radio or television reception, which can be determined by turning the equipment off and on, the user is encouraged to try to correct the interference by one or more of the following measures:

- Reorient or relocate the receiving antenna.
- Increase the separation between the equipment and receiver.
- Connect the equipment into an outlet on a circuit different from that to which the receiver is connected.
- Consult the dealer or an experienced radio/TV technician for help.



ZOOM CORPORATION

ITOHPIA Iwamotocho 2chome Bldg. 2F, 2-11-2, Iwamoto-cho,
Chiyoda-ku, Tokyo 101-0032, Japan
Web Site: <http://www.zoom.co.jp>

RT-223 - 5000-4